



Solis 4G Single Phase Inverter

Solis-1P(2.5-6)K-4G **Installation and Operation Manual**

(For Australia)

Ver 1.0

Ginlong Technologies Co., Ltd.

No. 57 Jintong Road, Binhai Industrial Park, Xiangshan, Ningbo,
Zhejiang, 315712, P.R.China.

Tel: +86 (0)574 6578 1806

Fax: +86 (0)574 6578 1606

Email: info@ginlong.com

Web: www.ginlong.com

Please adhere to the actual products in case of any discrepancies in this user manual.

If you encounter any problem on the inverter, please find out the inverter S/N
and contact us, we will try to respond to your question ASAP.



Ginlong Technologies Co., Ltd.

1. Introduction	2
1.1 Product Description	2
1.2 Packaging	3
1.3 Product Storage	4
2. Safety Instructions	5
2.1 Safety Symbols	5
2.2 General Safety Instructions	5
2.3 Notice For Use	7
2.4 Notice for Disposal	7
3. Overview	8
3.1 Front Panel Display	8
3.2 LED Status Indicator Lights	8
3.3 Keypad	8
3.4 LCD	8
4. Installation	9
4.1 Select Location for the Inverter	9
4.2 Mounting the Inverter	11
4.3 Electrical Connections	13
5. Start & Stop	25
6.1 Start the Inverter	25
6.2 Stop the Inverter	25
6. Operation	26
6.1 Main Menu	26
6.2 Information	26
6.3 Settings	28
6.4 Advanced Info.	29
6.5 Advanced Settings	33
6.6 AFCI function	48
7. Maintenance	49
8. Troubleshooting	50
9. Specifications	54
10. Appendix	70
10.1 Built-In DC Isolator Specification	70

1. Introduction

1.1 Product Description

Solis 4G Single Phase Inverters integrate DRM and backflow power control function, that is suitable for smart grid requirement.

This manual covers the 4G Single Phase Inverter model listed below:

Solis-1P2.5K-4G, Solis-1P3K-4G, Solis-1P3.6K-4G, Solis-1P4K-4G, Solis-1P4.6K-4G, Solis-1P5K-4G, Solis-1P5K-4G-MX, Solis-1P6K-4G

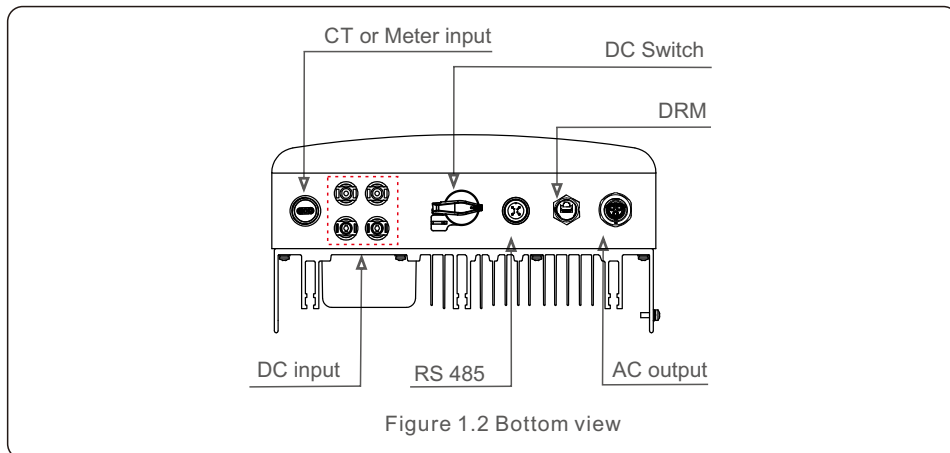
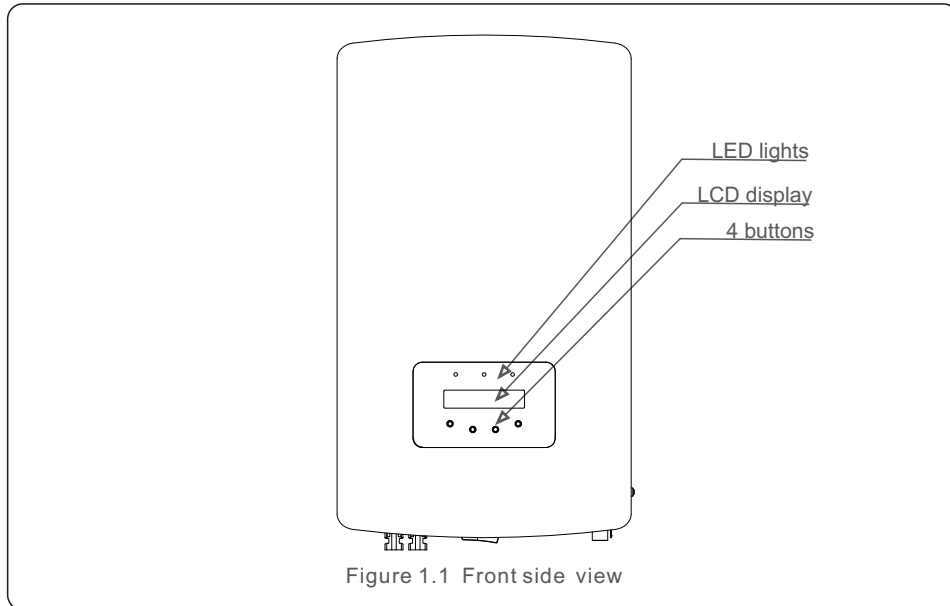

1. Introduction

1.2 Packaging

When you receive the inverter, please ensure that all the parts listed below are included:

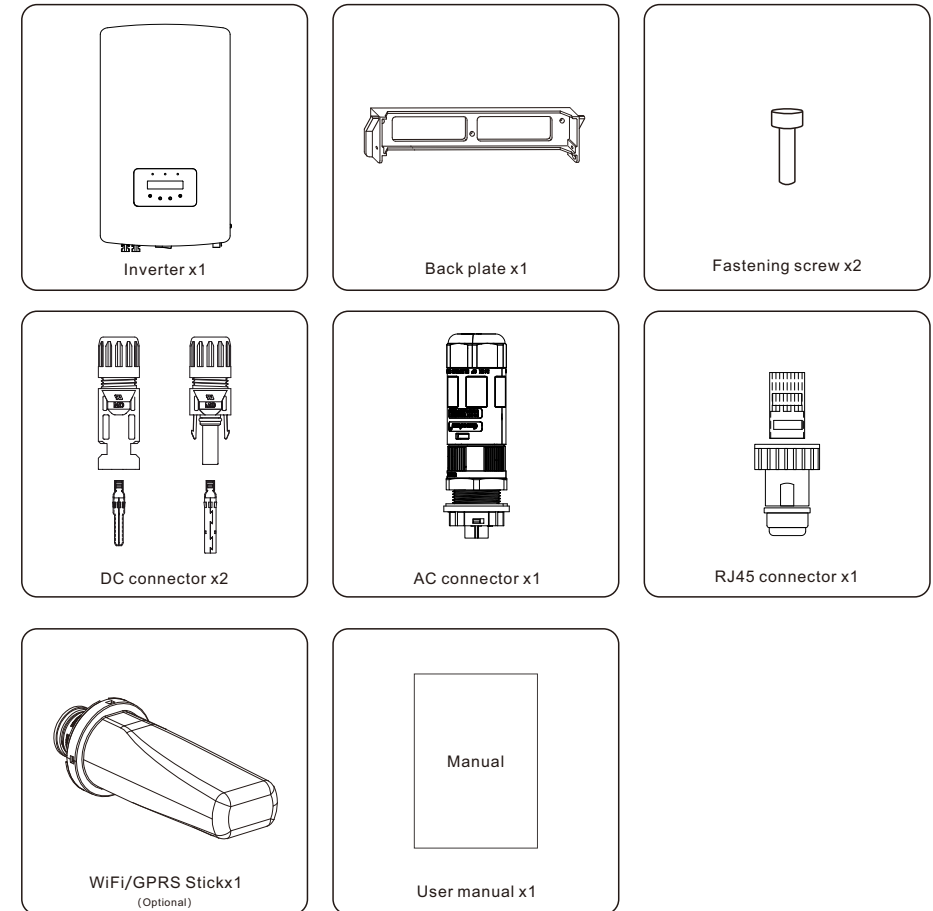

If anything is missing, please contact your local Solis distributor.

1. Introduction

1.3 Product Storage

If the inverter is not to be installed immediately, storage instructions and environmental conditions are below:

- Use the original box to repackage the inverter, seal with adhesive tape with the desiccant inside the box.
- Store the inverter(s) in a clean and dry place, free of dust and dirt.
- Storage temperature must be between -40°C and 70°C and the humidity should be between 0 and 95% non-condensing.
- Stack no more than four (4) inverters high.
- Keep box(es) away from corrosive materials to avoid damage to the inverter enclosure.
- Inspect packaging regularly. If packaging is damaged(wet, pest damage, etc), repackage the inverter immediately.
- Store the inverter(s) on a flat, hard surface - not inclined or upside down.
- After long-term storage, the inverter needs to be fully examined and tested by qualified service or technical personnel before using.
- Restarting after a long period of non-use requires the equipment to be inspected and, in some cases, the removal of oxidation and dust that has settled inside the equipment will be required.

2. Safety Instructions

2.1 Safety Symbols

Safety symbols used in this manual, which highlight potential safety risks and important safety information, are listed as follows:

**WARNING:**

WARNING symbol indicates important safety instructions, which if not correctly followed, could result in serious injury or death.

**NOTE:**

NOTE symbol indicates important safety instructions, which if not correctly followed, could result in some damage or the destruction of the inverter.

**CAUTION:**

CAUTION, RISK OF ELECTRIC SHOCK symbol indicates important safety instructions, which if not correctly followed, could result in electric shock.

**CAUTION:**

CAUTION, HOT SURFACE symbol indicates safety instructions, which if not correctly followed, could result in burns.

2.2 General Safety Instructions

**WARNING:**

Only devices in compliance with SELV (EN 69050) may be connected to the RS485 and USB interfaces.

**WARNING:**

Please don't connect PV array positive(+) or negative(-) to ground, it could cause serious damage to the inverter.

**NOTE:**

PV module used with inverter must have an IEC 61730 Class A rating.

2. Safety Instructions



WARNING:

Electrical installations must be done in accordance with the local and national electrical safety standards.



WARNING:

Do not touch any inner live parts until 5 minutes after disconnection from the utility grid and the PV input.



CAUTION:

Risk of electric shock. Do not remove cover. There is no user serviceable parts inside. Refer servicing to qualified and accredited service technicians.



WARNING:

To reduce the risk of fire, over-current protective devices (OCPD) are required for circuits connected to the Inverter. The DC OCPD shall be installed per local requirements. All photovoltaic source and output circuit conductors shall have disconnects that comply with the NEC Article 690, Part II. All Solis S5 Single Phase Inverters feature an integrated DC switch.



CAUTION:

The PV array (Solar panels) supplies a DC voltage when they are exposed to sunlight.



CAUTION:

The surface temperature of the inverter can exceed 75°C (167F). To avoid risk of burns, DO NOT touch the surface when inverter is operating. The inverter must be installed out of reach of children.



CAUTION:

Risk of electric shock from energy stored in capacitors of the Inverter. Do not remove cover for 5 minutes after disconnecting all power sources (service technician only). Warranty may be voided if the cover is removed without unauthorized.

2. Safety Instructions

2.3 Notice For Use

The inverter has been constructed according to the applicable safety and technical guidelines. Use the inverter in installations that meet the following specifications only:

- Permanent installation is required.
- The electrical installation must meet all the applicable regulations and standards.
- The inverter must be installed according to the instructions stated in this manual.
- The inverter must be installed according to the correct technical specifications.
- To startup the inverter, the Grid Supply Main Switch (AC) must be switched on, before the solar panel's DC isolator shall be switched on. To stop the inverter, the Grid Supply Main Switch (AC) must be switched off before the solar panel's DC isolator shall be switched off.
- Single phase inverters can be used in parallel and external devices should be used in accordance with the requirements of AS/NZS 4777.1. Single phase inverters can't be used in multiple-phase installations.

2.4 Notice for Disposal

This product shall not be disposed of with household waste. They should be segregated and brought to an appropriate collection point to enable recycling and avoid potential impacts on the environment and human health. Local rules in waste management shall be respected .

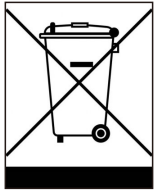

3. Overview

3.1 Front Panel Display

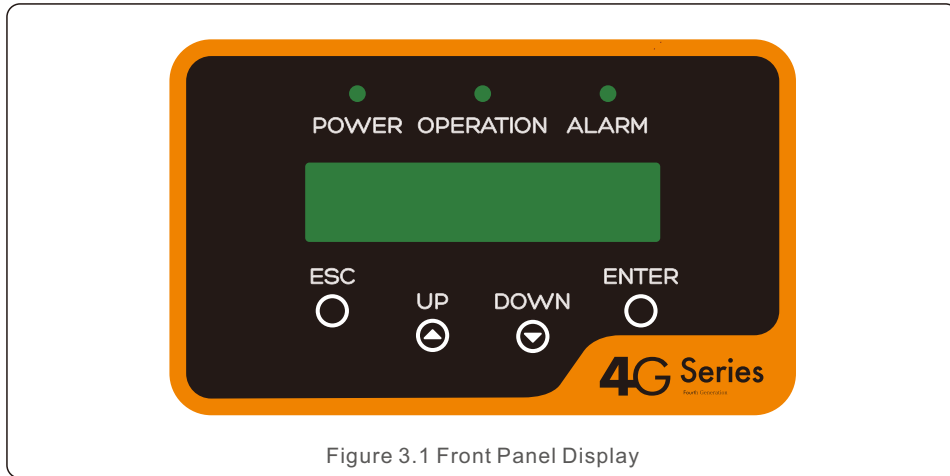

Figure 3.1 Front Panel Display

3.2 LED Status Indicator Lights

	Light	Status	Description
①	● POWER	ON	The inverter can detect DC power.
		OFF	No DC power or low DC power.
②	● OPERATION	ON	The inverter is operating properly.
		OFF	The inverter has stopped to supply power.
		FLASHING	The inverter is initializing.
③	● ALARM	ON	Alarm or fault condition is detected.
		OFF	The inverter is operating without fault or alarm.

Table 3.1 Status Indicator Lights

3.3 Keypad

There are four keys in the front panel of the Inverter(from left to right): ESC, UP, DOWN and ENTER keys. The keypad is used for:

- Scrolling through the displayed options (the UP and DOWN keys);
- Access to modify the adjustable settings (the ESC and ENTER keys).

3.4 LCD

The two-line Liquid Crystal Display (LCD) is located on the front panel of the Inverter, which shows the following information:

- Inverter operation status and data;
- Service messages for operator;
- Alarm messages and fault indications.

4. Installation

4.1 Select a Location for the Inverter

To select a location for the inverter, the following criteria should be considered:



WARNING: Risk of fire

Despite careful construction, electrical devices can cause fires.

- Do not install the inverter in areas containing highly flammable materials or gases.
- Do not install the inverter in potentially explosive atmospheres.

- Do not install in small closed spaces where air can not circulate freely. To avoid overheating, always make sure the flow of air around the inverter is not blocked.
- Exposure to direct sunlight will increase the operational temperature of the inverter and may cause output power limiting. Recommends inverter installed to avoid direct sunlight or raining.
- To avoid over heating ambient air temperature must be considered when choosing the inverter installation location. Recommends using a sun shade minimizing direct sunlight when the ambient air temperature around the unit exceeds 104°F/40°C.

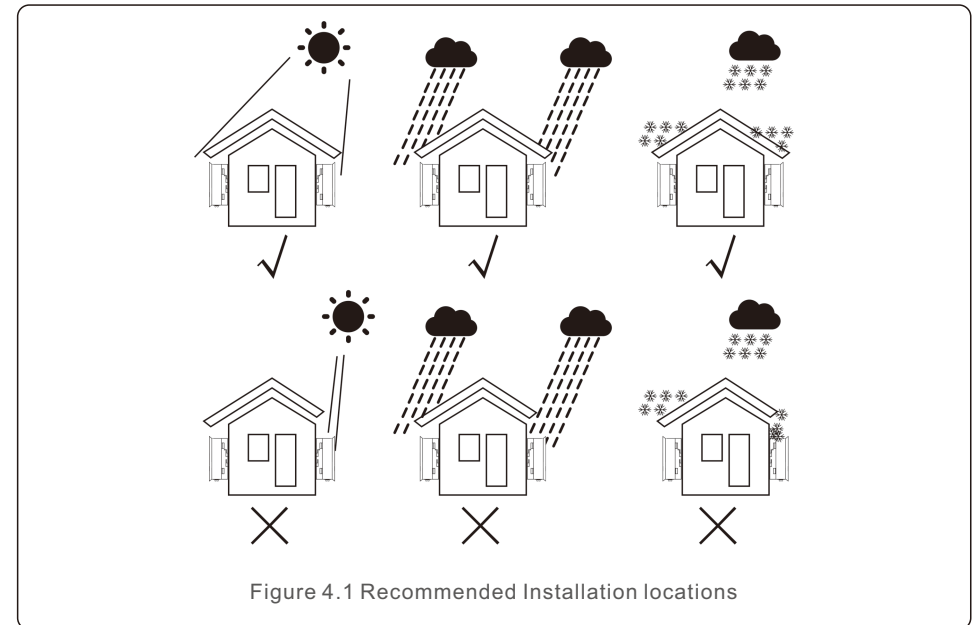
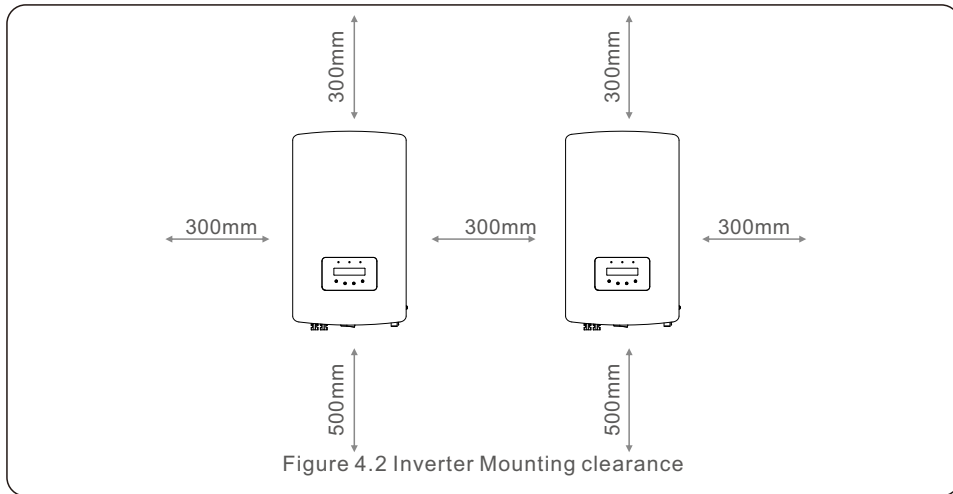

Figure 4.1 Recommended Installation locations

4. Installation

- Install on a wall or strong structure capable of bearing the weight.
- Install vertically with a maximum incline of +/- 5°. If the mounted inverter is tilted to an angle greater than the maximum noted, heat dissipation can be inhibited, and may result in less than expected output power.
- When 1 or more inverters are installed in one location, a minimum 12 inches clearance should be kept between each inverter or other object. The bottom of the inverter should be 20 inches clearance to the ground.
- The front side of the inverter should be 12 inch clearance to other object.



- Visibility of the LED status indicator lights and the LCD located at the front panel of the inverter should be considered.
- Adequate ventilation must be provided if the inverter is to be installed in a confined space.



NOTE: Nothing should be stored on or placed against the inverter.

4. Installation

4.2 Mounting the Inverter

Dimensions of mounting bracket:

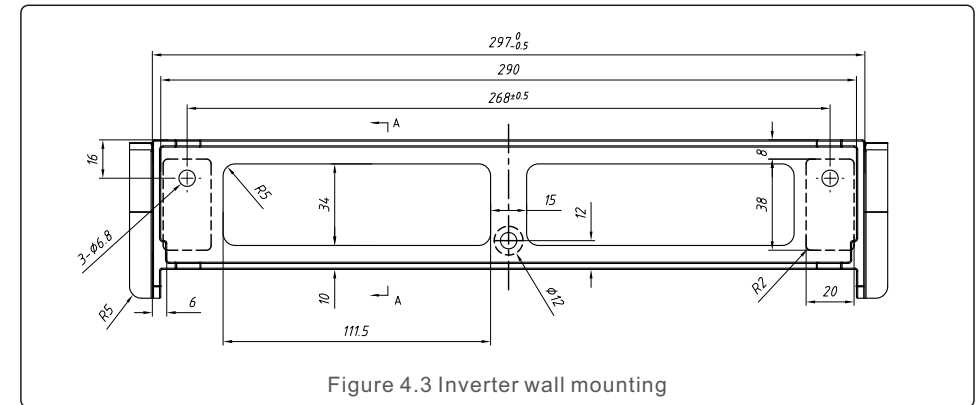

Please see Figure 4.4 and Figure 4.5 for instruction on mounting the inverter. The inverter shall be mounted vertically. The steps to mount the inverter are listed below.

1. According to the figure 4.2, select the mounting height of the bracket and mark the mounting holes. For brick walls, the position of the holes should be suitable for the expansion bolts.

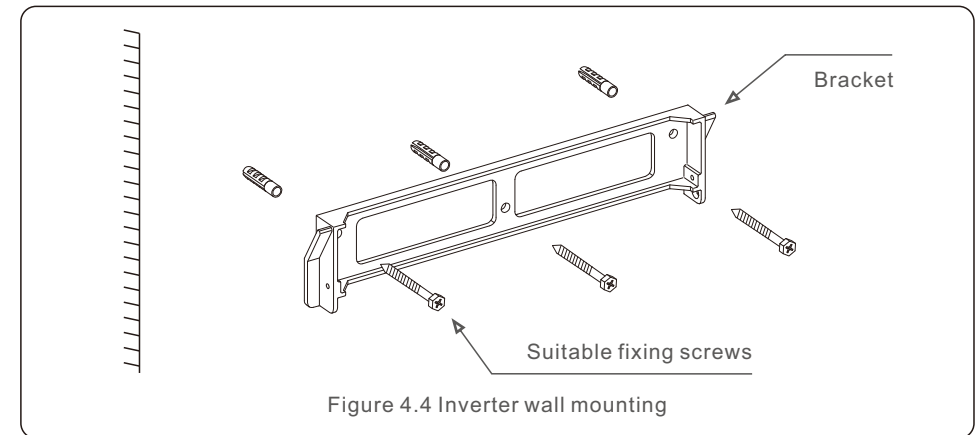

2. Make sure the bracket is horizontal. And the mounting holes (in Figure 4.4) are marked correctly. Drill the holes into wall at your marks.
3. Use the suitable expansion screws to fix the bracket on the wall.

4. Installation

4. Installation



WARNING:

The inverter must be mounted vertically.

4. Lift up the inverter (be careful to avoid body strain), and align the back bracket on the inverter with the convex section of the mounting bracket. Hang the inverter on the mounting bracket and make sure the inverter is secure (see Figure 4.5).

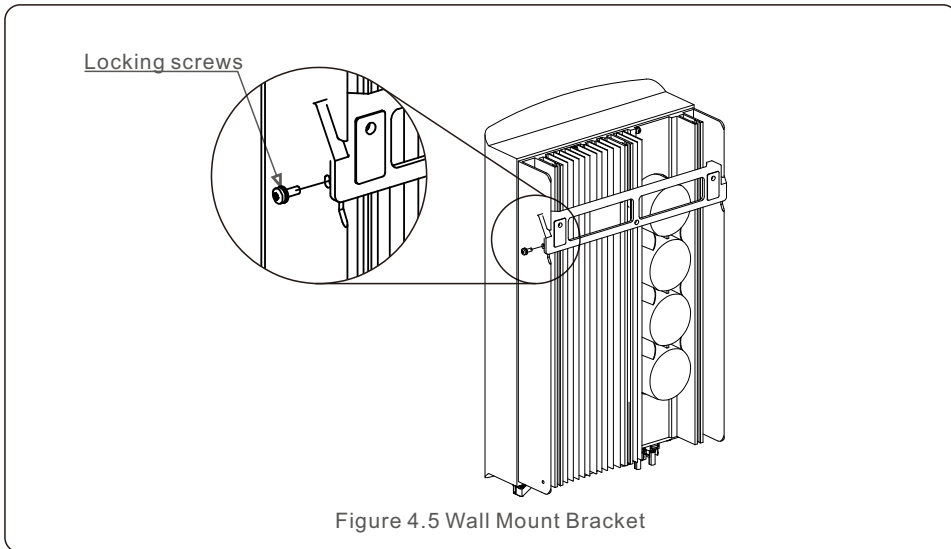

Figure 4.5 Wall Mount Bracket

5. Use M4*9 screws in accessory to lock the inverter to the mount bracket.

4.3 Electrical Connections

Inverter designs quick-connect terminal, so top cover needn't open during electrical connection. The sign meaning located the bottom of inverter, as shown below in table 4.1. All electrical connections are suit for the local or national standard.

+	Positive DC input terminal
-	Negative DC input terminal
DC 1	DC input terminal
DC 2	DC input terminal
DC SWITCH	Switch of DC input terminals
COM	RJ45 and terminal block for RS485 communication port
GRID	Connecting terminal of the Grid

Table 4.1 Electrical connection symbols

4.3.1 Connect PV side of inverter

The electrical connection of the inverter must follow the steps listed below:

1. Switch the Grid Supply Main Switch (AC) OFF.
2. Switch the DC Isolator OFF.
3. Assemble PV input connector to the Inverter.



Before connecting inverter, please make sure the PV array open circuit voltage is within the limit of the inverter.

Maximum 600Voc for

Solis-1P2.5K-4G Solis-1P3K-4G Solis-1P3.6K-4G Solis-1P4K-4G
 Solis-1P4.6K-4G Solis-1P5K-4G Solis-1P5K-4G-MX Solis-1P6K-4G



Before connection, please make sure the polarity of the output voltage of PV array matches the DC+ and DC- symbols.



Please don't connect PV array positive or negative pole to the ground, it could cause serious damages to the inverter.

4. Installation

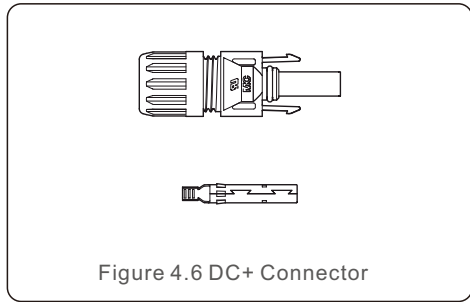

Figure 4.6 DC+ Connector

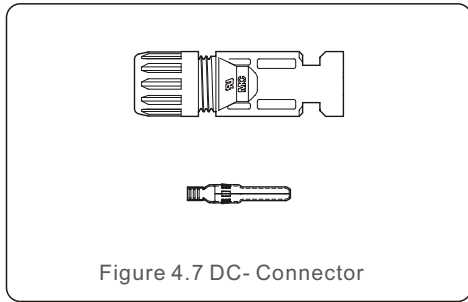



Figure 4.7 DC- Connector

 Please use approved DC cable for PV system.

Cable type	Cross section (mm ²)	
	Range	Recommended value
Industry generic PV cable (model:PV1-F)	4.0~6.0 (12~10AWG)	4.0 (12AWG)

The steps to assemble the DC connectors are listed as follows:

1. Strip off the DC wire for about 7mm, Disassemble the connector cap nut. (see Figure 4.8)
2. Insert the wire into the connector cap nut and contact pin. (see Figure 4.9)
3. Crimp the contact pin to the wire using a proper wire crimper. (see Figure 4.10)
4. Insert the contact pin to the top part of the connector and screw up the cap nut to the top part of the connector .(see figure 4.11).
5. Then connect the DC connectors to the inverter. Small click will confirm connection. (see figure 4.12)

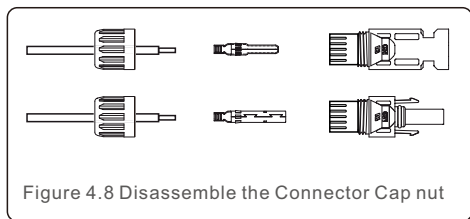

Figure 4.8 Disassemble the Connector Cap nut

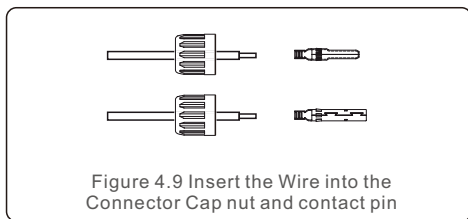

Figure 4.9 Insert the Wire into the Connector Cap nut and contact pin

4. Installation

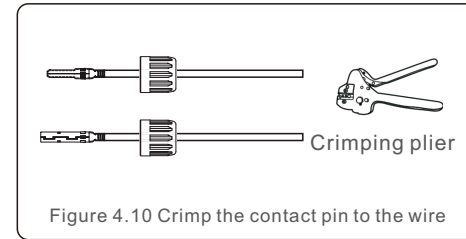

Figure 4.10 Crimp the contact pin to the wire

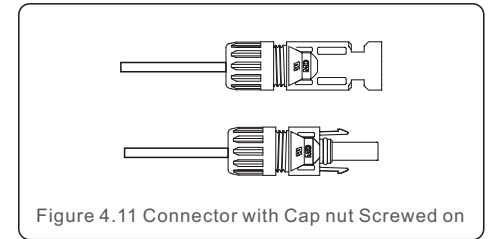

Figure 4.11 Connector with Cap nut Screwed on

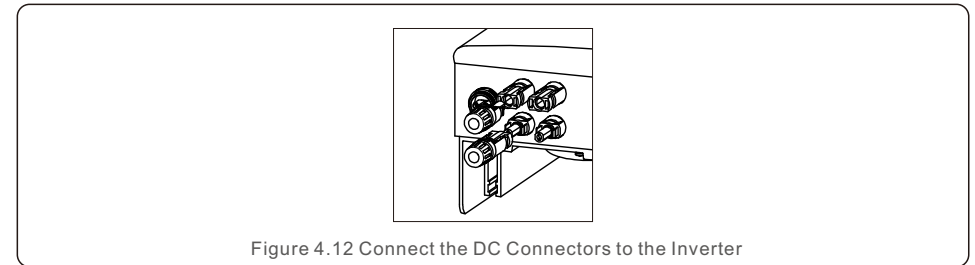



Figure 4.12 Connect the DC Connectors to the Inverter

 **Caution:** If DC inputs are accidentally reversely connected or inverter is faulty or not working properly, it is NOT allowed to turn off the DC switch as it will damage the inverter and even leads to a fire disaster.
The correct actions are:
*Use a clip-on ammeter to measure the DC string current.
*If it is above 0.5A, please wait for the solar irradiance reduces until the current decreases to below 0.5A.
*Only after the current is below 0.5A, you are allowed to turn off the DC switches and disconnect the PV strings.
Please note that any damages due to wrong operations are not covered in the device warranty.

4. Installation

4.3.2 Connect grid side of inverter

For all AC connections, 2.5- 6mm² 105 cable is required to be used. Please make sure the resistance of cable is lower than 1 ohm. If the wire is longer than 20m, it's recommended to use 6mm² cable.



There are "L", "N", "PE" symbols marked inside the connector, the Line wire of grid must be connected to L terminal, the Neutral wire of grid must be connected to "N" terminal and Earth wire must be connected to "PE".

Cable type	Cross section (mm ²)	
	Range	Recommended value
Industry generic PV cable	2.5~6.0	6.0

Table 4.2 Grid cable size

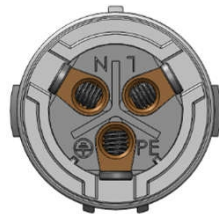

Figure 4.13 AC Grid Terminal Connector Inside

Each Solis 4G Single Phase Inverter is supplied with an AC grid terminal connector.

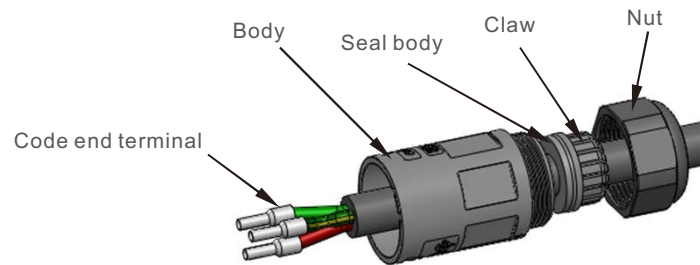

Figure 4.14 AC Grid Terminal Connector

4. Installation

The steps to assemble the AC grid terminal connectors are listed as follows:

a) Disassemble the AC connector. Strip the AC wires about 7mm.

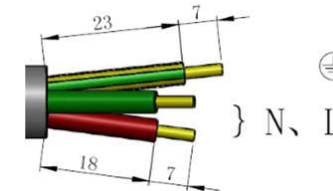

Figure 4.15 Stripped AC Wires

b) Fix the wires into the correct position. Torque 0.8N.m

Please try to pull out the wire to make sure it's well connected.

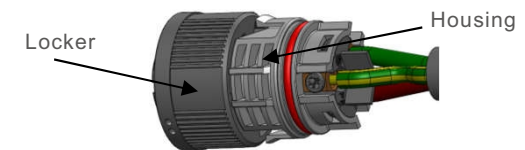

Figure 4.16 Connect Wires to the Terminal

c) Insert Seal and Clamp Finger into body, then tighten the nut, torque 2.5+/-0.5N.m.



Figure 4.17 Tighten up the Cap on the Terminal

4. Installation

d) Mating plug and socket:

Push the locker onto the socket housing completely, then rotate the locker according to the direction instructed by the marks on the locker. (Warning: hold the body)

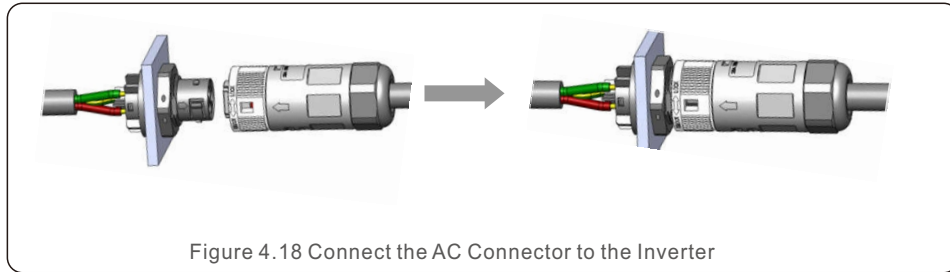

Figure 4.18 Connect the AC Connector to the Inverter



Note: Connection for Split phase grid.

When connect to 208/220/240V split phase, please connect L1 to "L" terminal, L2 to "N" terminal. Also connect earth to ground terminal.

4.3.3 External ground connection

An external ground connection is provided at the right side of inverter.

Prepare OT terminals: M4. Use proper tooling to crimp the lug to the terminal.

Connect the OT terminal with ground cable to the right side of inverter. The torque is 2N.m.

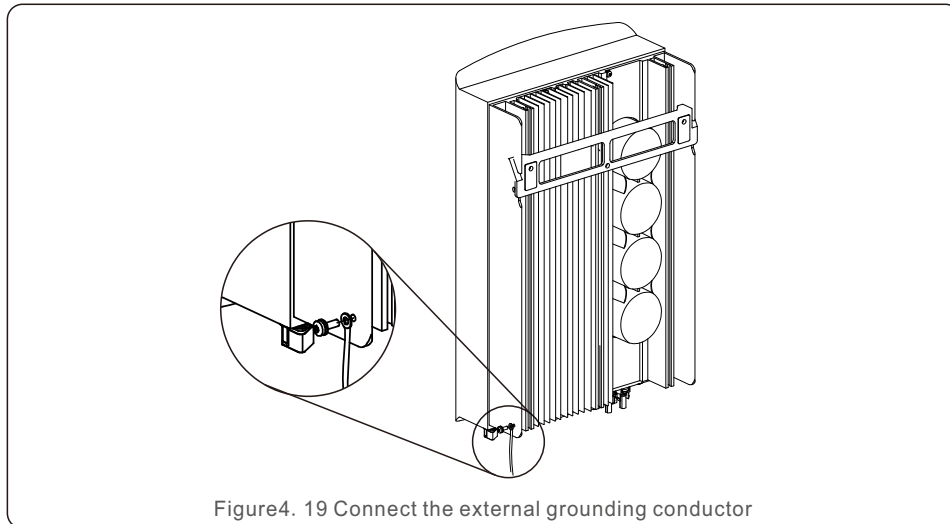

Figure4. 19 Connect the external grounding conductor

4. Installation

4.3.4 Max. over current protection device (OCPD)

To protect the inverter's AC grid connection conductors, Solis recommends installing breakers that will protect against overcurrent. The following table defines OCPD ratings for the Solis 4G Single Phase Inverters.

Inverter	Rated output voltage(V)	Rated output current (A)	Current for protection device (A)
Solis-1P2.5K-4G	230	13.3	20
Solis-1P3K-4G	230	15.7	20
Solis-1P3.6K-4G	230	16.0	20
Solis-1P4K-4G	230	21.0	25
Solis-1P4.6K-4G	230	23.8	30
Solis-1P5K-4G	230	25.0	30
Solis-1P5K-4G-MX	230	21.7	30
Solis-1P6K-4G	230	27.3	40

Table 4.3 Rating of grid OCPD

4.3.5 Inverter monitoring connection

The inverter can be monitored via Wi-Fi or GPRS. All Solis communication devices are optional (Figure 4.20). For connection instructions, please refer to the Solis Monitoring Device installation manuals.

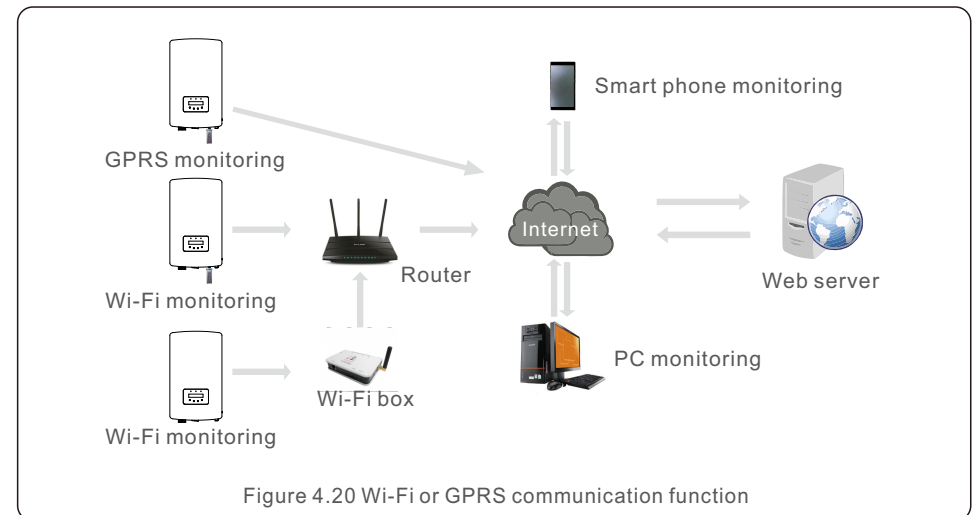

Figure 4.20 Wi-Fi or GPRS communication function

4. Installation

4. Installation

4.3.6 Electrical connection diagram

Refer to figure 4.21, which is a simple guidance for installing a solar system with PV inverter. A ADC isolator is required to be installed in the system between PV panels with inverter.

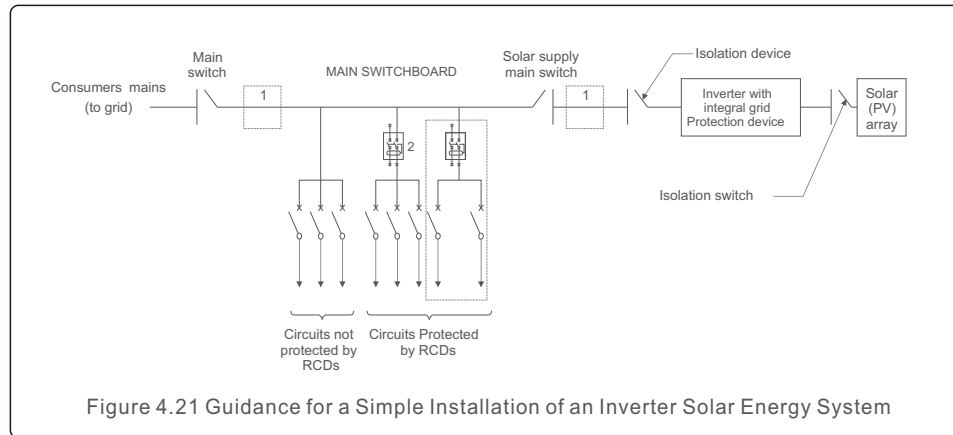

Figure 4.21 Guidance for a Simple Installation of an Inverter Solar Energy System

1. The RCD should be in parallel connection between the consumers mains and the solar supply.
2. More than one RCD may be used. Each RCD can protect one or more circuits.

4.3.7 Meter Connection(optional)

The inverter can work with a single phase smart meter to achieve Export Power Management function and/or 24hour consumption monitoring function.

NOTE
 Inverters are classified as "Meter Model" and "CT Model" due to hardware difference.
 Meter Model can only connect a smart meter.
 CT Model can only connect a smart sensor.
 Please consult Solis Sales Rep before placing the order.

NOTE
 To achieve Export Power Management function, the smart meter can be installed on either grid side or load side. To achieve 24hour consumption monitoring function, the smart meter can only be installed on grid side.

Two types of meters are supported:

Direct Insert Type Meter - Max input current 60A (Model:DDSD1352-C)

External CT Type Meter - 120A/40mA CT is supplied (Model: ACR10RD16TE)

Customer can place the order for a suitable meter from Solis Sales Reps.

Below are the connection diagrams of different meters connecting to different locations.

Detailed settings please refer to Section 6.5.12.

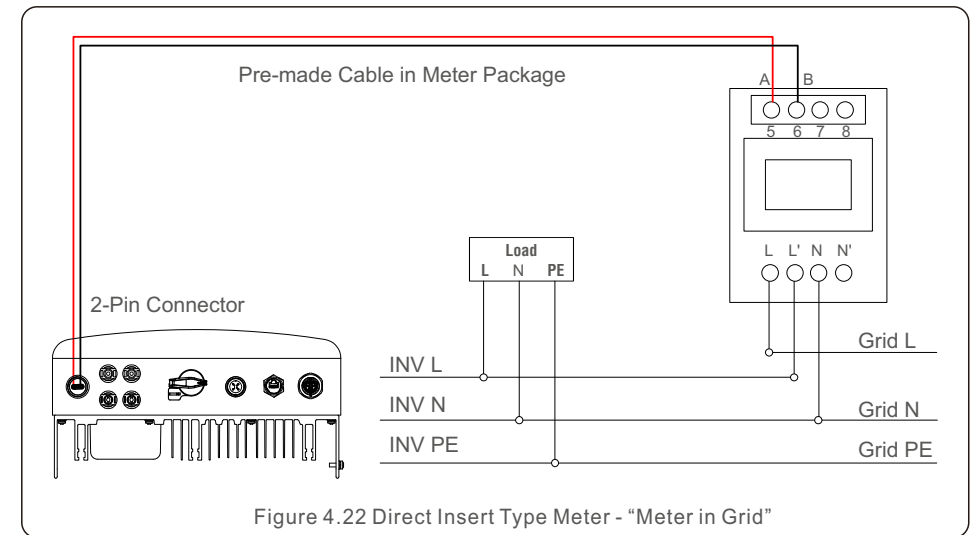

Figure 4.22 Direct Insert Type Meter - "Meter in Grid"

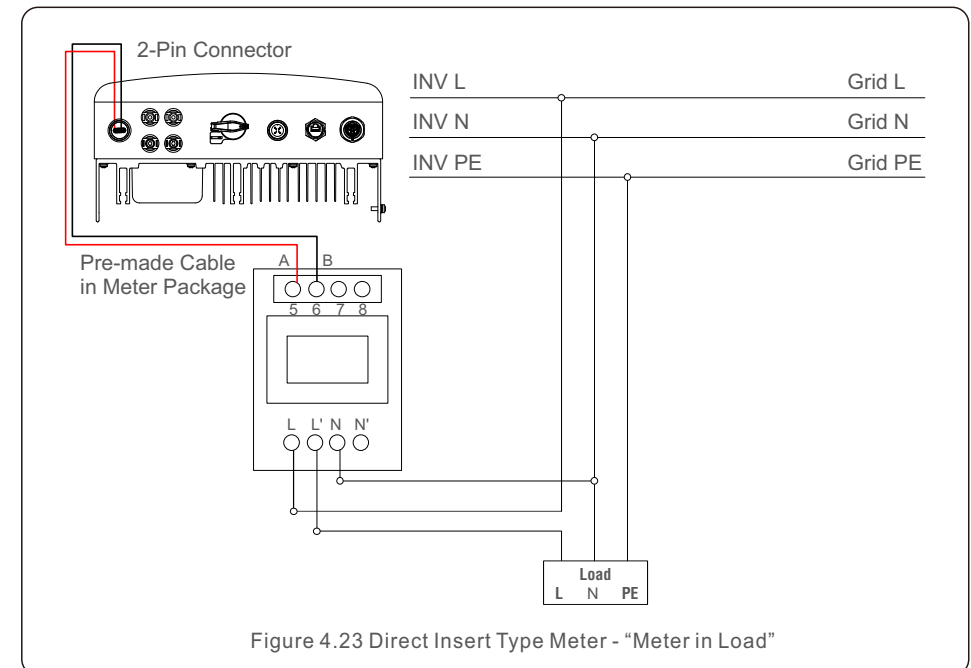
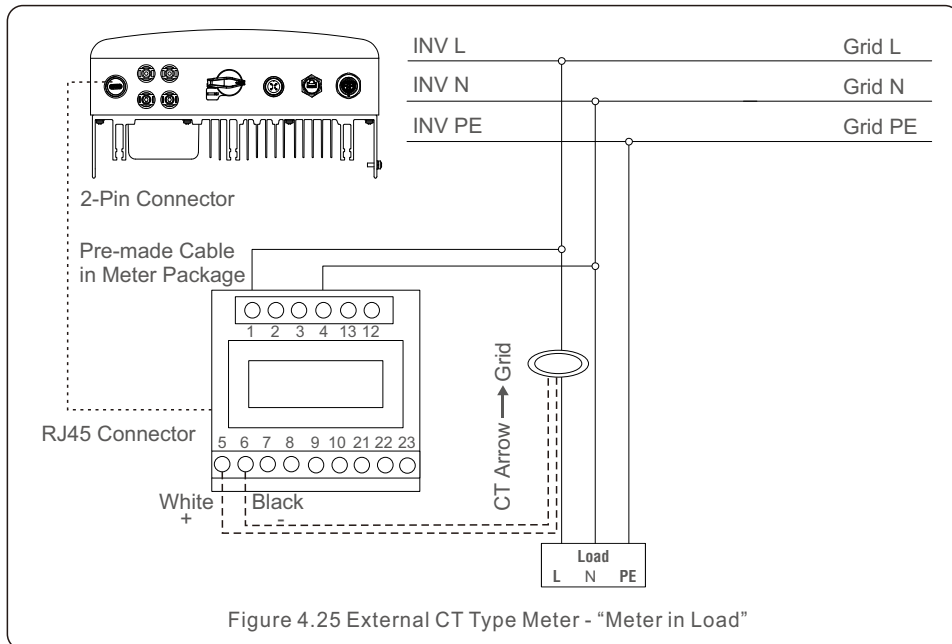
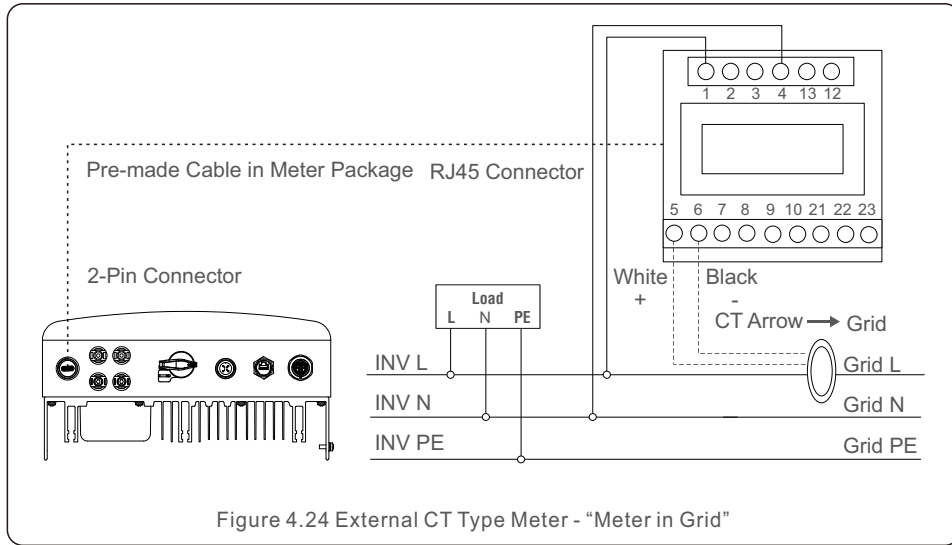

Figure 4.23 Direct Insert Type Meter - "Meter in Load"

4. Installation



4. Installation

4.3.8 CT connections(optional)

The inverter can work with a smart sensor to achieve Export Power Management function.



NOTE

Inverters are classified as "Meter Model" and "CT Model" due to hardware difference.

Meter Model can only connect a smart meter.

CT Model can only connect a smart sensor.

Please consult Solis Sales Rep before placing the order.



NOTE

To achieve Export Power Management function, the smart sensor must be installed on the grid side.

Below is the connection diagram of the smart sensor.

Detailed settings please refer to Section 6.5.12.

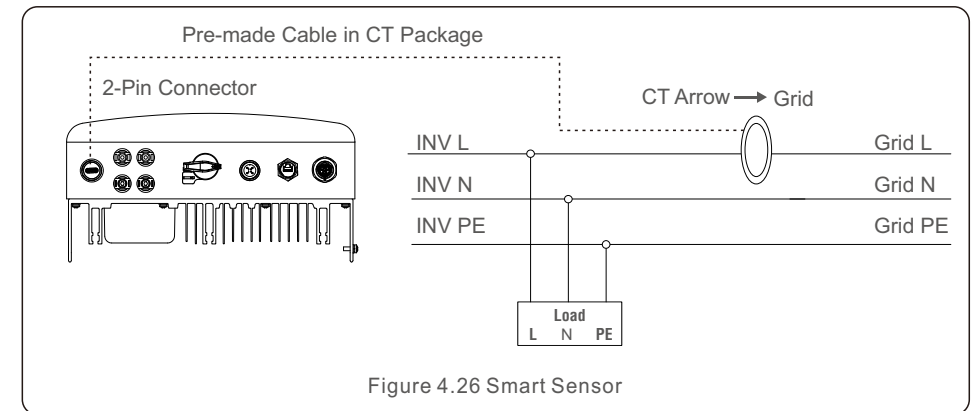

4.3.9 External Residual Current Device(RCD)

All series of Solis inverters are integrated with an internal residual current device to protect against any potential d.c component and a.c component of residual current.

Therefore, all Solis inverters, due to the design, are not able to feed in DC fault current to the system which fully complies with IEC60364-7-712.

If an external RCD is required to be installed by local regulations, Solis recommends installing a Type-A RCD with a threshold current higher than 100mA.

4. Installation

4.3.10 Logic interface connection

DRED means demand response enable device. The AS/NZS 4777.2:2020 required inverter need to support demand response mode(DRM). This function is for inverter that comply with AS/NZS 4777.2:2020 standard.

A RJ45 terminal is used for DRM connection.

Pin	Assignment for inverters capable of both charging and discharging	Pin	Assignment for inverters capable of both charging and discharging
1	DRM 1/5	5	RefGen
2	DRM 2/6	6	Com/DRM0
3	DRM 3/7	7	V+
4	DRM 4/8	8	V-

Table 4.4



NOTE:

Solis inverter is designed to provide 12V power for DRED.

Please follow below steps to assemble RJ45 connector.

1.Insert the network cable into the communication connection terminal of RJ45.



Figure 4.27 RJ45 communication connection terminals

2.Use the network wire stripper to strip the insulation layer of the communication cable. According to the standard line sequence of figure 4.28 connect the wire to the plug of RJ45, and then use a network cable crimping tool to make it tight.

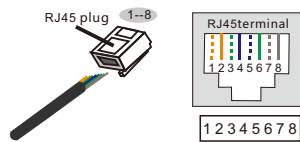

Correspondence between the cables and the stitches of plug

Pin 1: white and orange ; Pin 2: orange
 Pin 3: white and green; Pin 4: blue
 Pin 5: white and blue; Pin 6: green
 Pin 7: white and brown; Pin 8: brown

Figure 4.28 Strip the insulation layer and connect to RJ45 plug

3.Connect RJ45 to DRM port.

4.3.11 Earth Fault Alarm

Solis inverters fully comply with IEC62109-2 in terms of earth fault alarm (PV insulation detection and protection). When the earth fault on PV side happens, the yellow alarm indicator will flash and the alarm code "PVISO-PRO" will show up on the LCD screen. The inverter can't start to generate until the earth fault is resolved. Please refer to the troubleshooting section of this manual to resolve the earth fault or contact Solis service team for help.

5. Start & Stop

5.1 Start the Inverter

To start up the Inverter, it is important that the following steps are strictly followed:

1. Switch the grid supply main Switch (AC) ON first.
2. Switch the DC switch ON. If the voltage of PV arrays are higher than start up voltage, the inverter will turn on. The red LED power will light.
3. When both the DC and the AC sides supply to the inverter, it will be ready to generate power. Initially, the inverter will check both its internal parameters and the parameters of the AC grid, to ensure that they are within the acceptable limits. At the same time, the green LED will flash and the LCD displays the information of INITIALIZING.
4. After 30-300 seconds (depending on local requirement), the inverter will start to generate power. The green LED will be on continually and the LCD displays GENERATING.



WARNING:

Do not touch the surface when the inverter is operating. It may be hot and cause burns.

5.1.1 Inverter working status

When inverter working normally, there would be 5 status :

- Generating: Inverter is working normally
- LimByTemp: Inverter power limited by over ambient temperature.
- LimByFreq: Inverter power limited by over grid frequency
- LimByVg: Inverter power limited by over grid voltage
- LimByVar: Inverter power limited by generating reactive power.

5.2 Stop the Inverter

To stop the inverter, it is mandatory that the steps below are followed in the exact order outlined.

1. Select "Grid Off" in the Advanced Setting of Inverter LCD.
2. Turn off the AC Switch between Solis inverter and Grid.
3. Wait approximately 30 seconds (during this time, the AC side capacitors are dissipating energy). If the inverter has DC voltage above the start-up threshold, the red POWER LED will be lit. Switch the DC switch OFF.
4. Confirm all LED's switch OFF (~one (1) minute).



CAUTION

Although the inverter DC disconnect switch is in the OFF position and all the LED's are OFF, operators must wait five (5) minutes after the DC power source has been disconnected before opening the inverter cabinet. DC side capacitors can take up to five (5) minutes to dissipate all stored energy.

6. Operation

6. Operation

During normal operation, the display alternately shows the power and the operation status with each screen lasting for 10 seconds (see Figure 6.1). Screens can also be scrolled manually by pressing the UP and DOWN keys. Press the ENTER key to access to the Main Menu.

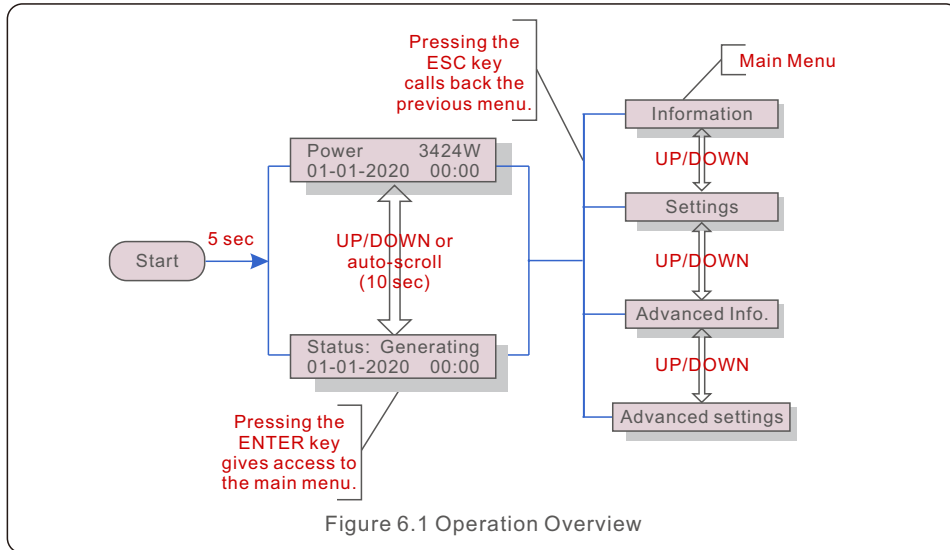

6.1 Main Menu

There are four submenus in the Main Menu (see Figure 6.1):

1. Information
2. Settings
3. Advanced Info.
4. Advanced Settings

6.2 Information

The Solis 4G Single Phase Inverter main menu provides access to operational data and information. The information is displayed by selecting "Information" from the menu and then by scrolling up or down.

Display	Duration	Description
V_DC1 350.8V I_DC1 5.1A	10 sec	V_DC1: Shows input 01 voltage value. I_DC1: Shows input 01 current value.
V_DC2 350.8V I_DC2 5.1A	10 sec	V_DC2: Shows input 02 voltage value. I_DC2: Shows input 02 current value.
V_Grid 230.4V I_Grid 8.1A	10 sec	V_Grid: Shows the grid's voltage value I_Grid: Shows the grid's current value.
Status: Generating Power: 1488W	10 sec	Status: Shows instant status of the Inverter. Power: Shows instant output power value.
Grid Frequency F_Grid 60.06Hz	10 sec	F_Grid: Shows the grid's frequency value.
Total Energy 0258458 kwh	10 sec	Total generated energy value.
This Month: 0123kwh Last Month: 0123kwh	10 sec	This Month: Total energy generated this month. Last Month: Total energy generated last month.
Today: 15.1kwh Yesterday: 13.5kwh	10 sec	Today: Total energy generated today. Yesterday: Total energy generated yesterday.
Inverter SN 00000000000000	10 sec	Display series number of the inverter.
Export_P: +0000W Export_I: 00.0A	10 sec	Power of ERM. Current of EPM.
Work Mode: NULL DRM Number: 08	10 sec	Work Mode: The work mode of inverter. DRM Number: Show the number 01-08.
Meter EnergyP 0000000.00kWh	10 sec	Meter EnergyP: The active power.

Table 6.1 Information list

6. Operation

6.2.1 Lock screen

Pressing the ESC key returns to the Main Menu. Pressing the ENTER key locks (Figure 6.2(a)) or unlocks (Figure 6.2 (b)) the screen.

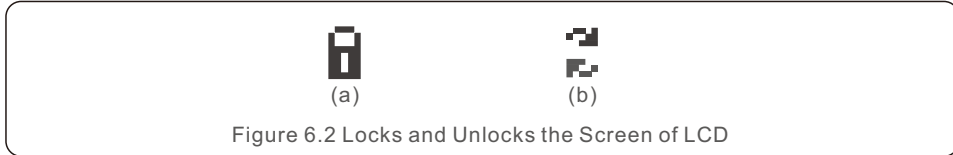

6.3 Settings

The following submenus are displayed when the Settings menu is selected:

- 1. Set Time
- 2. Set Address

6.3.1 Set Time

This function allows time and date setting. When this function is selected, the LCD will display a screen as shown in Figure 6.3.

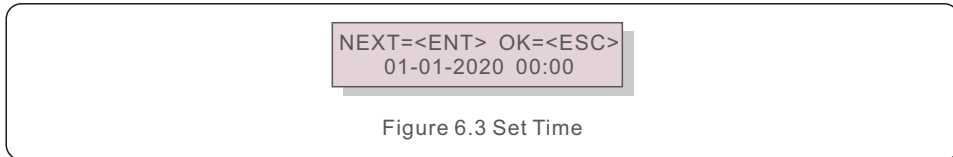

Press the UP/DOWN keys to set time and data. Press the ENTER key to move from one digit to the next (from left to right). Press the ESC key to save the settings and return to the previous menu.

6.3.2 Set Address

This function is used to set the address when muti inverters are connected to single monitor. The address number can be assigned from "01"to "99". The default address number of Solis 4G Single Phase Inverter is "01".

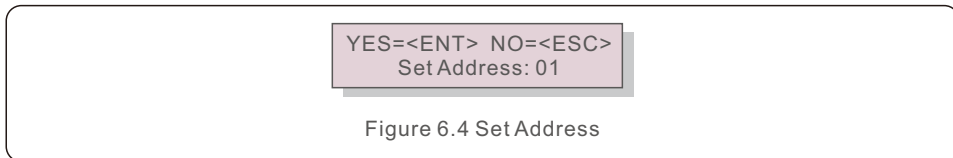

Press the UP/DOWN keys to set the address. Press the ENTER key to save the settings. Press the ESC key to cancel the change and return to the previous menu.

6. Operation

6.4 Advanced Info - Technicians Only

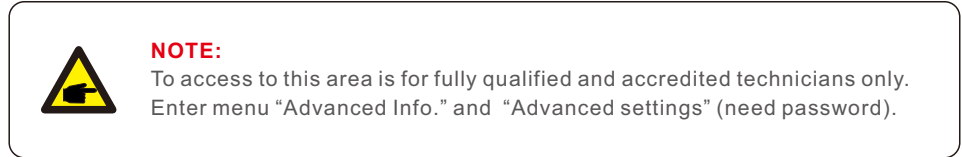

Select "Advanced Info." from the Main Menu. The screen will require the password as below:

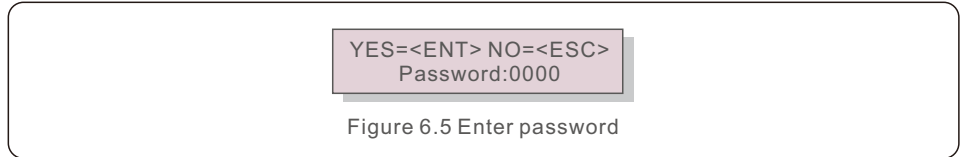

The default password is "0010".

Please press "down" to move the cursor, press "up" to select the number.

After enter the correct password the Main Menu will display a screen and be able to access to the following information.

- 1. Alarm Message
- 2. Running message
- 3. Version
- 4. Daily Energy
- 5. Monthly Energy
- 6. Yearly Energy
- 7. Daily Record
- 8. Communication Data
- 9. Warning Message
- 10. Inspection

The screen can be scrolled manually by pressing the UP/DOWN keys. Pressing the ENTER key gives access to a submenu. Press the ESC key to return to the Main Menu.

6.4.1 Alarm Message

The display shows the 100 latest alarm messages (see Figure 6.6). Screens can be scrolled manually by pressing the UP/ DOWN keys. Press the ESC key to return to the previous menu.

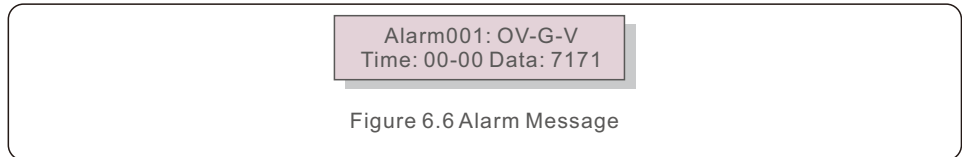

6. Operation

6.4.2 Running Message

This function is for maintenance person to get running message such as internal temperature, Standard No. etc.
Screens can be scrolled manually by pressing the UP/DOWN keys.

6.4.3 Version

The screen shows the model version and the software version of the Inverter



Model: 08
Software Version: D20001

Figure 6.7 Model Version and Software Version

6.4.4 Daily Energy

The function is for checking the energy generation for selected day.



YES=<ENT> NO=<ESC>
Select: 2020-01-01

Figure 6.8 Select date for daily energy

Press DOWN key to move the cursor to day, month and year, press UP key to change the digit.
Press Enter after the date is fixed.

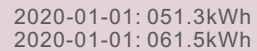

2020-01-01: 051.3kWh
2020-01-01: 061.5kWh

Figure 6.9 Daily energy

Press UP/DOWN key to move one date from another.

6.4.5 Monthly Energy

The function is for checking the energy generation for selected month.



YES=<ENT> NO=<ESC>
Select: 2020-01

Figure 6.10 Select month for monthly energy

Press DOWN key to move the cursor to day and month, press UP key to change the digit.
Press Enter after the date is fixed.

6. Operation

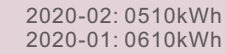

2020-02: 0510kWh
2020-01: 0610kWh

Figure 6.11 Month energy

Press UP/DOWN key to move one date from another.

6.4.6 Yearly Energy

The function is for checking the energy generation for selected year.



YES=<ENT> NO=<ESC>
Select: 2020

Figure 6.12 Select year for yearly energy

Press DOWN key to move the cursor to day and year, press UP key to change the digit.
Press Enter after the date is fixed.

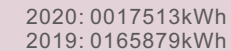

2020: 0017513kWh
2019: 0165879kWh

Figure 6.13 Yearly energy

Press UP/DOWN key to move one date from another.

6.4.7 Daily record

The screen shows history of changing settings. Only for maintenance personnel.

6.4.8 Communication Data

The screen shows the internal data of the Inverter (see Figure 6.14), which is for service technicians only.

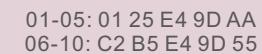

01-05: 01 25 E4 9D AA
06-10: C2 B5 E4 9D 55

Figure 6.14 Communication Data

6. Operation

6.4.9 Warning Message

The display shows the 100 latest warn messages (see Figure 6.15). Screens can be scrolled manually by pressing the UP/ DOWN keys. Press the ESC key to return to the previous menu.

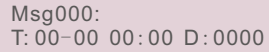

Msg000:
T: 00-00 00:00 D: 0000

Figure 6.15 Warning Message

6.4.10 Inspection

This information is used to check which standard is current in effective and which working mode is enabled.

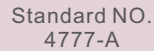

Standard NO.
4777-A

Figure 6.16



Work Mode:
Volt-Watt

Figure 6.17

6. Operation

6.5 Advanced Settings - Technicians Only



NOTE:

To access to this area is for fully qualified and accredited technicians only. Please follow 6.4 to enter password to access this menu.

Select Advanced Settings from the Main Menu to access the following options:

1. Select Standard
2. Grid ON/OFF
3. 24H Switch
4. Clear Energy
5. Reset Password
6. Power Control
7. Calibrate Energy
8. Special Settings
9. STD. Mode Settings
10. Restore Settings
11. HMI Update
12. Internal EPM Set
13. External EPM Set
14. Restart HMI
15. Debug Parameter
16. DSP Update
17. Power Parameter

6.5.1 Selecting Standard

This function is used to select the grid's reference standard (see Figure 6.18).



YES=<ENT> NO=<ESC>
Standard:AS4777-A

Figure 6.18

Press the UP/DOWN keys to select the standard 4777-A, 4777-B, 4777-C and 4777-N for compliance with AS/NZS4777.2:2020. The standard AS4777-15 is for AS/NZS4777.2:2015.



NOTE:

This function is for technicians use only.

6. Operation



NOTE:

For different countries, the grid standard needs to be set as different according to local requirements. If there is any doubt, please consult Solis service technicians for details.

The default protection settings and setting range for different regions are showing below:

Region	Australia A	Australia B	Australia C	New Zealand	Setting Range
Standard Code Name	4777-A	4777-B	4777-C	4777-N	
OV-G-V1	265V	265V	265V	265V	230-276V
OVGV1-T	1.5S	1.5S	1.5S	1.5S	1-2S
OV-G-V2	275V	275V	275V	275V	230-276V
OVGV2-T	0.1S	0.1S	0.1S	0.1S	0.1-2S
UN-G-V1	180V	180V	180V	180V	38-230V
UNGV1-T	10S	10S	10S	10S	10-11S
UN-G-V2	70V	70V	70V	70V	38-230V
UNGV2-T	1.5S	1.5S	1.5S	1.5S	1-2S
OV-G-F1	52HZ	52HZ	55HZ	55HZ	50-55HZ
OVGF1-T	0.1S	0.1S	0.1S	0.1S	0.1-2S
OV-G-F2	52HZ	52HZ	55HZ	55HZ	50-55HZ
OVGF2-T	0.1S	0.1S	0.1S	0.1S	0.1-2S
UN-G-F1	47HZ	47HZ	45HZ	45HZ	45-50HZ
UNGF1-T	0.1S	1.5S	1.5S	5S	1-6S
UN-G-F2	47HZ	47HZ	45HZ	45HZ	45-50HZ
UNGF2-T	0.1S	1.5S	1.5S	5S	1-6S
Startup-T	60S	60S	60S	60S	10-600S
Restore-T	60S	60S	60S	60S	10-600S
Recover-VH	253V	253V	253V	253V	230-276V
Recover-VL	205V	205V	205V	196V	115-230V
Recover-FH	50.15Hz	50.15Hz	50.15Hz	50.15Hz	50-52Hz
Recover-FL	47.5Hz	47.5Hz	47.5Hz	47.5Hz	47-50Hz
Start-VH	253V	253V	253V	253V	230-276V
Start-VL	205V	205V	205V	196V	115-230V
Start-FH	50.15Hz	50.15Hz	50.15Hz	50.15Hz	50-52Hz
Start-FL	47.5Hz	47.5Hz	47.5Hz	47.5Hz	47-50Hz

Table 6.2

6. Operation

6.5.2 Grid ON/OFF

This function is used to start up or stop the power generation of Solis Single Phase Inverter.



Figure 6.19 Set Grid ON/OFF

Screens can be scrolled manually by pressing the UP/DOWN keys. Press the ENTER key to save the setting. Press the ESC key to return to the previous menu.

6.5.3 24H Switch

This function controls the 24H hours consumption function enable or disable.

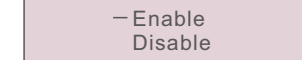

Figure 6.20 Set 24H ON/OFF

NOTE:



When this is enabled, the inverter LCD will still be alive at night with the power LED light on. If the grid is in malfunction at night, the system can't recover even after the grid is back to normal but the consumption data will still be recorded in the meter. Until the sunrise, the system will start to work again while the meter data can be uploaded to the Solis monitoring system to calibrate the load consumption data.

6.5.4 Clear Energy

Clear Energy can reset the history yield of inverter.



These two functions are applicable by maintenance personnel only, wrong operation will prevent the inverter from working properly.

6. Operation

6.5.5 Reset Password

This function is used to set the new password for menu “Advanced info.” and “Advanced information” .



YES=<ENT> NO=<ESC>
Password: 0000

Figure 6.21 Set new password

Enter the right password before set new password. Press the DOWN key to move the cursor, Press the UP key to revise the value. Press the ENTER key to execute the setting. Press the ESC key to return to the previous menu.

6.5.6 Power control

Active and reactive power can be set through power setting button. There are 5 item for this sub menu:

1. Set output power
2. Set Reactive Power
3. Out_P With Restore
4. Rea_P With Restore
5. Select PF Curve



This function is applicable by maintenance personnel only, wrong operation will prevent the inverter from reaching maximum power.

6.5.7 Calibrate Energy

Maintenance or replacement could clear or cause a different value of total energy. Use this function could allow user to revise the value of total energy to the same value as before. If the monitoring website is used the data will be synchronous with this setting automatically.



YES=<ENT> NO=<ESC>
Energy:0000000kWh

Figure 6.22 Calibrate energy

Press the DOWN key to move the cursor, Press the UP key to revise the value. Press the ENTER key to execute the setting. Press the ESC key to return to the previous menu.

6. Operation

6.5.8 Special Settings



This function is applicable by maintenance personnel only, wrong operation will prevent the inverter from working properly.

6.5.9 STD Mode settings

There are 10 settings under STD. Mode Settings.

1. Working Mode Set
2. Power Rate Limit
3. Freq Derate Set
4. 10mins Voltage Set
5. Q3Tau Settings
6. P3Tau Settings
7. Control Switches
8. Power Priority
9. Initial Settings
- 10.DRM Settings

6.5.9.1 Working Mode Set

Solis AU version inverters have the following working mode settings:

1. NULL
2. P Mode Settings
- 3.Q Mode Settings

1. NULL

Description: Inverter will not be under any working mode.

2. P Mode Settings

This P Mode Settings include 1 working mode: Volt-Watt

2.1 Volt-Watt

Description: Inverter will change the active output power based on grid voltage.

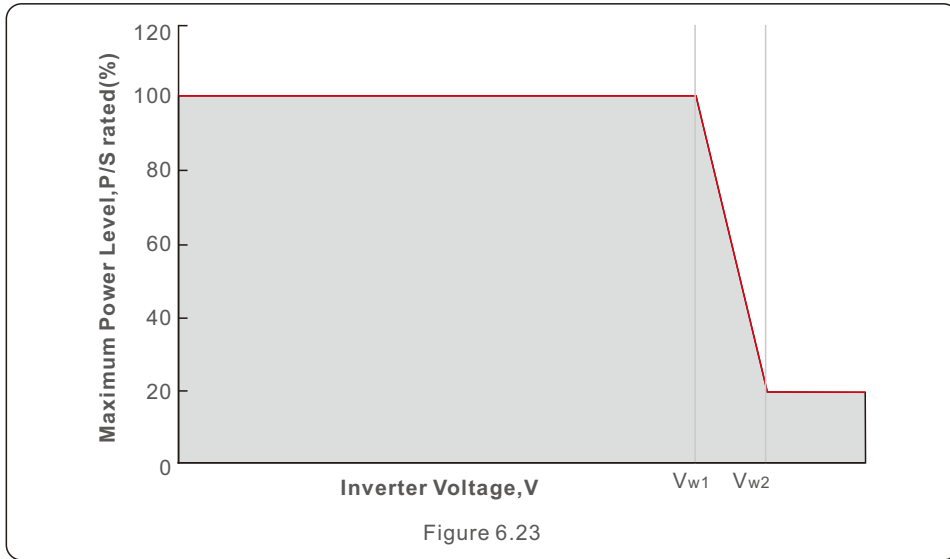

Figure 6.23

Status: Enable/Disable (Note: This is used to enable or disable the Volt-Watt mode)

Voltage 1: 207V

P-Limit 1: 100%

Voltage 2: 220V

P-Limit 2: 100%

Voltage 3 (Vw1):

235-255V (Default: 4777-A(253V); 4777-B(250V);4777-C(253V);4777-N(242V))

P-Limit 3: 100%

Voltage 4 (Vw2):

240-265V (Default: 4777-A(260V); 4777-B(260V);4777-C(250V);4777-N(250V))

P-Limit 4: 0%-20% (Default: 20% for 4777-A; 4777-B; 4777-C; 4777-N)

3. Q Mode Settings

This Q Mode Settings include 5 working modes:

Disable, Volt-Var, Fixed-PF, Reac-Power, P-factor

3.1 Disable

Description: This mode will disable the reactive power response working modes

3.2 Volt-Var

Description: Inverter will change the reactive output power based on grid voltage.

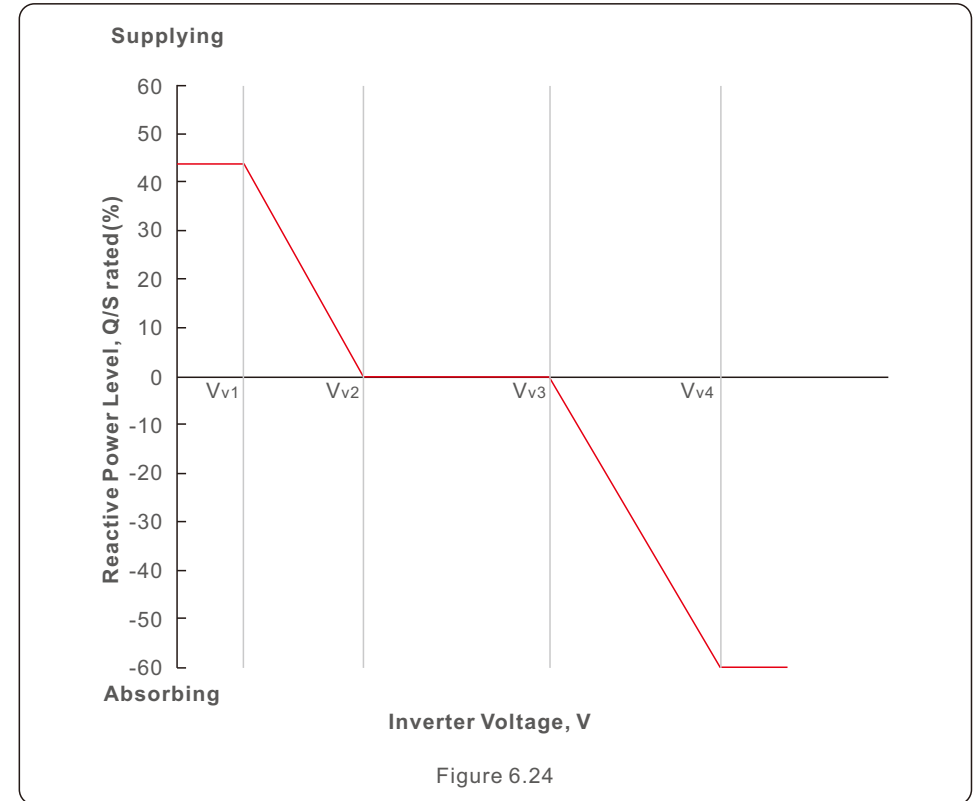

Figure 6.24

Voltage 1 (Vv1):

180-230V (Default: 4777-A(207V); 4777-B(205V);4777-C(215V);4777-N(207V))

Voltage 2(Vv2) :

180-230V (Default: 4777-A(220V); 4777-B(220V);4777-C(230V);4777-N(220V))

Voltage 3(Vv3) :

230-265V (Default: 4777-A(240V); 4777-B(235V);4777-C(240V);4777-N(235V))

Voltage 4(Vv4) :

230-265V (Default: 4777-A(258V); 4777-B(255V);4777-C(255V);4777-N(244V))

Leading(Supplying) :

+30~+60% (Default: 4777-A(+44%); 4777-B(+30%);4777-C(+44%);4777-N(+60%))

Lagging(Absorbing) :

-30~-60% (Default: 4777-A(-60%); 4777-B(-40%);4777-C(-60%);4777-N(-60%))

6. Operation

3.3 Fixed PF

Description: This mode is to set a fixed power factor output
Range: -0.8~+0.8
Default: 1

3.4 Reac-Power

Description: This mode is to set a fixed reactive power output
Range: -60%~+60%
Default: 0%

3.5 Power-PF

Description: This mode is not required in Australia.

6.5.9.2 Power Rate Limit

To set the power rate limits for increase and decrease in power level per minute.
Wgra+: 5-100%, Default: 16%
Wgra-: 5-100%, Default: 16%

6.5.9.3 Freq Derate Set

To set the frequency response limits for response to a decrease/increase in frequency.

OVF_Start(F_ULCO): 50.1Hz~50.5Hz
(Default: 4777-A(50.25Hz), 4777-B(50.15Hz), 4777-C(50.5Hz), 4777-N(50.2Hz))
OVF_Stop(F_Pmin): 51Hz~53Hz
(Default: 4777-A(52Hz), 4777-B(52Hz), 4777-C(53Hz), 4777-N(52Hz))
UNF_Start(F_LLCO): 49.5Hz~49.9Hz
(Default: 4777-A(49.75Hz), 4777-B(49.85Hz), 4777-C(49.5Hz), 4777-N(49.8Hz))
UNF_Stop(F_Pmax): 47Hz~49Hz
(Default: 4777-A(48Hz), 4777-B(48Hz), 4777-C(47Hz), 4777-N(48Hz))

6.5.9.4 10mins Voltage Set

To set the 10mins average protection limit.
Range: 244V to 258V
Default: 4777-A(258V); 4777-B(258V); 4777-C(258V); 4777-N(249V)

6.5.9.5 DRM Settings

“DRM ON/OFF” is used to enabled or disable the functionality of the DRM port.
“AU DRM Q Set” is used to define the reactive power absorption for DRM 3 or DRM 7.
Range: 0~ 60%

6. Operation

6.5.10 Restore Settings

Restore setting could set all item in 6.5.8 special setting to default.
The screen shows as below:

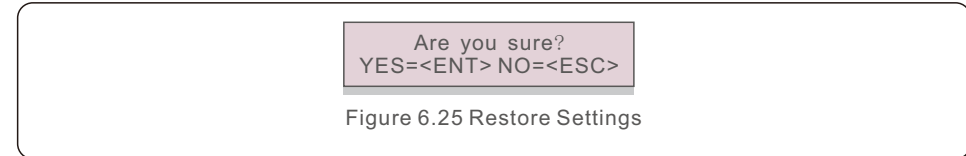

Figure 6.25 Restore Settings

Press the Enter key to save the setting after setting grid off.
Press the ESC key to return the previous mean.

6.5.11 HMI Update

This function is used for updating the LCD program.



This function is applicable by maintenance personnel only, wrong operation will prevent the inverter from reaching maximum power.

6.5.12 Internal EPM Set



NOTE:

This section includes two functions related to the smart meter or smart sensor. Please refer to section 4.3.7 or 4.3.8 for detailed connection diagrams.

Function 1: Internal Export Power Management Function

Inverters can work with a smart meter OR a smart sensor to dynamically limit the export power of the system. Zero injection can be achieved.

Smart meter can be installed either on the grid side OR the load side.

Smart sensor can only be installed on the grid side.

Function 2: 24 Hour Consumption Monitoring Function

Only applicable if Solis monitoring system is used.

Inverters can work with a smart meter to monitor the load consumption data for the whole day and the data will be displayed on the Solis monitoring system.

Smart meter can only be installed on the grid side.



NOTE:

Please refer to below instructions for different user scenarios.

Scenario 1. Only Function 1 is required

Using a Smart Meter:

Step 1: Refer to Section 4.3.7 to connect the smart meter on the grid side or load side.

Step 2: Select the corresponding meter model in Section 6.5.12.4

Step 3: Select the Section 6.5.12.1 Mode Select as Option 2(Meter in Load) or Option 3 (Meter in Grid) accordingly.

Step 4: Configure the Section 6.5.12.2 to set the allowed backflow power.

Step 5: Configure the Section 6.5.12.3 to enable the failsafe function (If necessary).

Using a Smart Sensor:

Step 1: Refer to Section 4.3.8 to connect the smart sensor on the grid side.

Step 2: Select the Section 6.5.12.1 Mode Select as Option 5(Current Sensor).

Step 3: Configure the "CT Sampling Ratio" and "CT Link Test" if necessary.

Step 4: Configure the Section 6.5.12.2 to set the allowed backflow power.

Step 5: Configure the Section 6.5.12.3 to enable the failsafe function (If necessary).



Scenario 2. Both Function 1 and 2 are required

Using a Smart Meter:

Step 1: Refer to Section 4.3.7 to connect the smart meter on the grid side.

Step 2: Select the corresponding meter model in Section 6.5.12.4

Step 3: Select the Section 6.5.11.1 Mode Select as Option 3(Meter in Grid).

Step 4: Select the Section 6.5.3 24H Switch as "Enable".

Step 5: Configure the Section 6.5.11.2 to set the allowed backflow power.

Step 6: Configure the Section 6.5.11.3 to enable the failsafe function (If necessary).

Step 7: Configure the Solis monitoring system (Please refer to the manual of monitoring device)

If customer does not want to enable the export power control function, please change the "backflow power" to the max output power of the inverter in Step 5 OR simply select the mode as "consumption monitor" in Step 3 and skip Step 5-6.

Select EPM Settings from the Main Menu to access the following options:

- 1. Mode Select 2. Soft Hard Lmt Set 3. Fail safe ON/OFF 4. Meter Select**

6.5.12.1 Mode Select

There are 5 settings in this menu as below:

- 1. EPM OFF 2. Meter in Load 3. Meter in Grid 4. Consumption Monitor 5. Current sensor**

EPM OFF: Functions are disabled

Meter in Load: Solis Smart Meter is connected in the load branch circuit.

Meter in Grid: Solis Smart Meter is connected in the grid connection point (The backflow power is default as 0W).

Consumption Monitor: Solis Smart Meter is connected in the grid connection point (The backflow power setting is not applicable).

Current sensor: Solis Smart Sensor is connected in the grid connection point.



NOTE:

For option 5 (Current sensor), there are several sub-settings available when "Current sensor" is selected.

• CT Sampling Ratio

This setting is used to define the CT sampling ratio if customer didn't use the default CT supplied by Solis.

The default CT is 100A:33.33mA (Default ratio is 3000:1)

-> CT Sampling Ratio

YES=<ENT> NO=<ESC>
Ratio:3000:1

• CT Link Test

This setting is used to check the direction of the CT (Not compulsory)

The result is only valid if the following conditions are met.

1. Load power is over 500W.
2. Inverter is set as "Grid OFF" in the LCD.
3. CT is connected to the inverter CT port and the CT is placed at the grid side.

CT Link State
Correct



NOTE:

There are 3 states in the CT Link Test

"Error" means the CT is installed in the wrong direction, please change it.

"Can not judge" means the load power is too small and the result is not credible.

"Correct" means the CT is installed correctly.

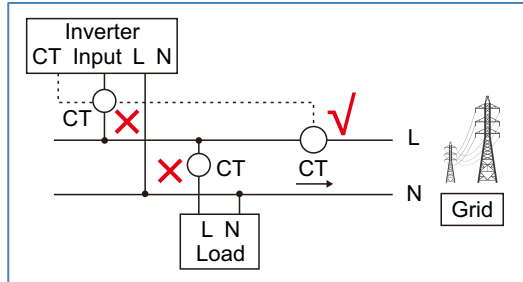

6.5.12.2 Soft Hard Lmt Set

1. Soft Backflowpower 2. Hard Limit 3. Hard Backflowpower

->Soft Backflowpower
Hard Limit

YES=<ENT> NO=<ESC>
Power:-00000W

Figure 6.26 Soft Backflowpower

Soft Backflowpower
->Hard Limit

YES=<ENT> NO=<ESC>
Hard export Lmt: ON

Figure 6.27 Hard Limit

Hard Limit
->Hard Backflowpower

YES=<ENT> NO=<ESC>
Power:-00000W

Figure 6.28 Hard Backflowpower



NOTE:

These settings are designed to comply with AS/NZS4777.2:2020, but the function has not been tested according to AS/NZS4777.2:2020 by third party certification organization. The "soft backflowpower" is to dynamically control the inverter output to meet the system export limit. When "Hard Limit" is set to ON and the "Hard Backflow power" is reached, the inverter will shutdown within 5s and give alarm as "EPM-HardLimit".



NOTE:

Positive values indicate the amount of power is allowed to export to the grid. Negative values indicate a more strict control to limit the export power in advance thus ensuring exact no power is feeding into the grid.

6.5.12.3 Fail safe ON/OFF

This setting is used to give out an alarm (stop inverter generation as well) when the CT/Meter connection is lost during operation.

It can prevent potential backflow power into the grid when the system loses control.

YES=<ENT> NO=<ESC>
Fail Safe Set:ON

Figure 6.29 Set the Fail Safe ON/OFF

It is only mandatory to turn on this function when the inverter is installed in UK due to the G100 regulation. For other regions, customers can enable or disable the function as they desire.



NOTE:

When the failsafe function is ON and CT/Meter is disconnected somehow, the inverter will stop generation and give "Failsafe" alarm on the LCD. When the failsafe function is OFF and CT/Meter is disconnected somehow, the inverter will keep the output power as the last moment when the CT/Meter is still connected. After a restart, the inverter will output at full power without limit.

6. Operation

6.5.12.4 Meter Select

The setting is used to define the correct meter that is connected to the inverter.

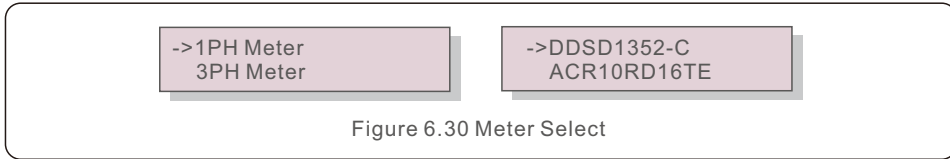

Figure 6.30 Meter Select

For Solis single phase inverters, please select "1PH Meter" and then select the corresponding meter model.

6.5.13 External EPM Set

This setting should only be turned on when Solis external EPM device is used.

Two options are available: 5G-EPM and Others-EPM.

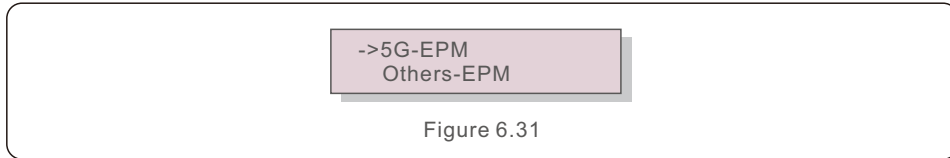
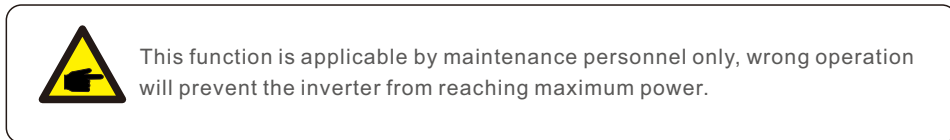

Figure 6.31

5G-EPM Failsafe Option should be turned ON when 5G series EPM device is used
Others-EPM Failsafe Option should be turned ON when 2G series EPM device is used
Only one option can be activated each time.

6.5.14 Restart HMI

The function is used for restart the HMI.



6.5.15 Debug Parameter

This function is used for manufacturer maintenance personnel only.

6.5.16 DSP Update

The function is used for update the DSP.

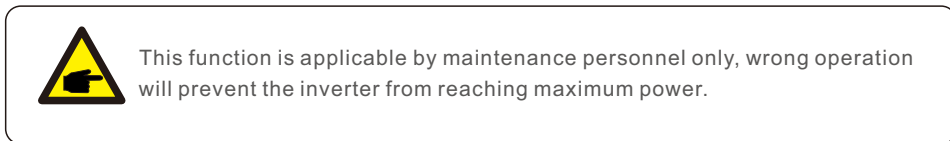

6. Operation

6.5.17 Power Parameter

This function is used for calibrate inverter output energy. It will not impact the energy count for inverter with RGM.

The screen shows:

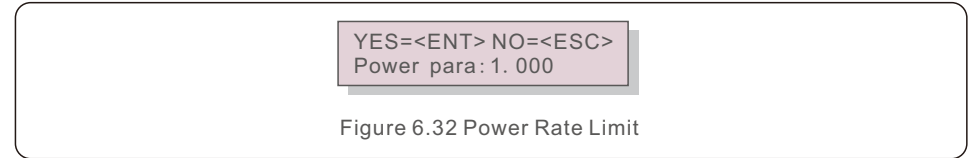
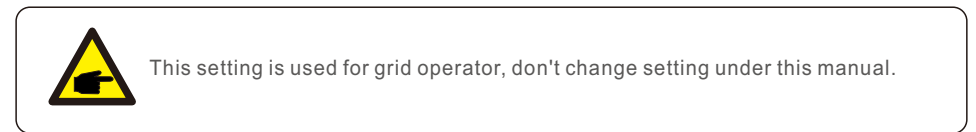

Figure 6.32 Power Rate Limit

Press the Down key to move the cursor.

Press the Up key to change the digit.

Please press the Enter to save the setting and press the ESC key to return to the previous menu.



6.6 AFCI function

Solis inverters have the built-in AFCI function which can detect the arc fault on the DC circuit and shut down the inverter to prevent a fire disaster.

6.6.1 Enable the AFCI function

The AFCI function can be enabled in the following.

Path:

Advanced Setting -> Password: 0010 ->Special Settings -> AFCI Set -> AFCI ON/OFF -> ON

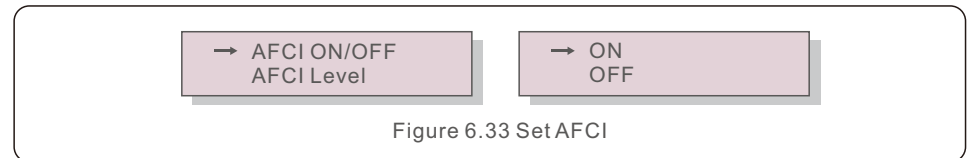

Figure 6.33 Set AFCI



Warning:

The "AFCI Level" is reserved for Solis technicians ONLY. Do not change the sensitivity otherwise it will lead to frequent false alarms or malfunctions. Solis is not responsible for any further damages caused by unauthorized modifications.



NOTE:

The setting corresponds to the current status as well which can be used to inspect the ON/OFF state of the AFCI function.

6.6.2 Arc Fault

During the normal operation, if an DC arc is detected, the inverter will shut down and give out the following alarm:

ARC-FAULT
Restart Press ESC 3s

Figure 6.34 Arc Fault

Installer needs to thoroughly inspect the DC circuit to ensure all the cables are correctly fastened.

Once the DC circuit issue has been fixed or it is confirmed to be OK, press "ESC" for 3s and wait for the inverter to restart.

Solis 4G Single Phase Inverter does not require any regular maintenance.

However, cleaning the dust on heat-sink will help the inverter to dissipate the heat and increase its life time. The dust can be removed with a soft brush.



CAUTION:

Do not touch the inverter's surface when it is operating. Some parts of the inverter may be hot and cause burns. Turn off the inverter (refer to Section 5.2) and wait for a cool-down period before any maintenance or cleaning operation.

The LCD and the LED status indicator lights can be cleaned with a damp cloth if they are too dirty to be read.



NOTE:

Never use any solvents, abrasives or corrosive materials to clean the inverter.

8. Troubleshooting

The inverter is designed in accordance with the most important international grid-tied standards and safety and electromagnetic compatibility requirements. Before delivering to the customer, the inverter has been subjected to several tests to ensure its optimal operation and reliability.

In case of failure, the LCD screen will display an alarm message. In this case, the inverter may stop feeding into the grid. The failure descriptions and their corresponding alarm messages are listed in Table 8.1:

Alarm Message	Failure description	Solution
No power	Inverter no power on LCD	1. Check PV input connections 2. Check DC input voltage (single phase >120V, three phase >350V) 3. Check if PV+/- is reversed
LCD show initializing all the time	can not start-up	1. Check if the connector on main board or power board are fixed. 2. Check if the DSP connector to power board are fixed.
OV-G-V01/02/03/04	Over grid voltage	1. Resistant of AC cable is too high. Change bigger size grid cable 2. Adjust the protection limit if it's allowed by electrical company.
UN-G-V01/02	Under grid voltage	1. Use user define function to adjust the protection limit if it's allowed by electrical company.
OV-G-F01/02	Over grid frequency	
UN-G-F01/02	Under grid frequency	
Reverse-GRID	Wrong AC polarity	1. Check the polarity of AC connector.
Reverse-DC	Reverse DC polarity	1. Check the polarity of DC connector.
NO-GRID	No grid voltage	1. Check connections and grid switch. 2. Check the grid voltage inside inverter terminal.
OV-DC01/02/03/04	Over DC voltage	1. Reduce the module number in series
OV-BUS	Over DC bus voltage	1. Check inverter inductor connection 2. Check driver connection
UN-BUS01/02	Under DC bus voltage	
GRID-INTF01/02	Grid interference	1. Restart inverter 2. Change power board
OV-G-I	Over grid current	
IGBT-OV-I	Over IGBT current	
DC-INTF OV-DCA-I	DC input overcurrent	1. Restart inverter 2. Identify and remove the string to the fault MPPT 2. Change power board
IGFOL-F	Grid current tracking fail	1. Restart inverter or contact installer.
IG-AD	Grid current sampling fail	

8. Troubleshooting

Alarm Message	Failure description	Solution
OV-TEM	Over Temperature	1. Check inverter surrounding ventilation. 2. Check if there's sunshine direct on inverter in hot weather.
INI-FAULT	Initialization system fault	1. Restart inverter or contact installer.
DSP-B-FAULT	Comm. failure between main and slave DSP	
12Power-FAULT	12V power supply fault	
PV ISO-PRO 01/02	PV isolation protection	1. Remove all DC input, reconnect and restart inverter one by one. 2. Identify which string cause the fault and check the isolation of the string.
ILeak-PRO 01/02/03/04	Leakage current protection	1. Check AC and DC connection 2. Check inverter inside cable connection.
RelayChk-FAIL	Relay check fail	1. Restart inverter or contact installer.
DCinj-FAULT	High DC injection current	1. Restart inverter or contact installer.
Screen OFF with DC applied	Inverter internally damaged	1. Do not turn off the DC switches as it will damage the inverter. 2. Please wait for the solar irradiance reduces and confirm the string current is less than 0.5A with a clip-on ammeter and then turn off the DC switches. 3. Please note that any damages due to wrong operations are not covered in the device warranty.
AFCI self-detection (model with AFCI module)	AFCI module self-detect fault	1. Restart inverter or connect technician.
Arcing protection (model with AFCI module)	Detect arc in DC circuit	1. Check inverter connection whether arc exists and restart inverter.

Table 8.1 Fault message and description

8. Troubleshooting



NOTE:

If the inverter displays any alarm message as listed in Table 8.1; please turn off the inverter (refer to Section 5.2 to stop your inverter) and wait for 5 minutes before restarting it (refer to Section 5.1 to start your inverter). If the failure persists, please contact your local distributor or the service center. Please keep ready with you the following information before contacting us.

1. Serial number of Solis Single Phase Inverter;
2. The distributor/dealer of Solis Single Phase Inverter (if available);
3. Installation date.
4. The description of problem (i.e. the alarm message displayed on the LCD and the status of the LED status indicator lights. Other readings obtained from the Information submenu (refer to Section 6.2) will also be helpful.);
5. The PV array configuration (e.g. number of panels, capacity of panels, number of strings, etc.);
6. Your contact details.

9. Specifications

Model	Solis-1P2.5K-4G
Max. DC input voltage (Volts)	550
Rated DC voltage (Volts)	250
Startup voltage (Volts)	60
MPPT voltage range (Volts)	50...450
Max. input current (Amps)	11+11
Max short circuit input current (Amps)	17.2+17.2
MPPT number/Max input strings number	2/2
Rated output power (Watts)	2500
Max. output power (Watts)	2750
Rated apparent output power (VA)	2500
Max. apparent output power (VA)	2750
Rated grid voltage (Volts)	1/N/PE, 230
Grid voltage range (Volts)	184...264
Rated output current (Amps)	13.3
Power Factor (at rated output power)	0.8leading~0.8lagging
THDi (at rated output power)	<5%
Rated grid frequency (Hertz)	50
Operating frequency range (Hertz)	45...55
Max. efficiency	97.8%
EU efficiency	97.1%
MPPT efficiency	>99.5%
Dimensions	310W*543H*160D (mm)
Weight	11.5kg
Topology	Non-Isolated
Operating ambient temperature range	-25°C...+60°C
Relative humidity	0-100%
Ingress protection	IP65
Noise emission (typical)	<20 dBA
Cooling concept	Natural convection
Max. operation altitude	2000m
Designed lifetime	>20 years
Grid connection standard	AS/NZS 4777.2, IEC 62116, IEC 61727, IEC 60068, IEC 61683, EN 50530
Safety/EMC standard	IEC 62109-1/-2, IEC 61000-6-2/-3
DC connection	MC4 connector
AC connection	Quick connection plug
Display	LCD, 2×20 Z
Communication	RS485, Optional: Wi-Fi, GPRS
Warranty	5 years (Extend to 20 years)

9. Specifications

Model	Solis-1P2.5K-4G
Max inverter backfeed current to array (Amps)	0
Peak Inrush current (Amps)	1.33
Peak Inrush Duration (ms)	5
Max output fault current (Amps)	16.625
Protective Class	Class I
Overvoltage category	II(PV), III(MAINS)
Active anti-islanding method	Active frequency shifting
Decisive voltage class	DVC

9. Specifications

Model	Solis-1P3K-4G
Max. DC input voltage (Volts)	600
Rated DC voltage (Volts)	330
Startup voltage (Volts)	120
MPPT voltage range (Volts)	90...520
Max. input current (Amps)	11+11
Max short circuit input current (Amps)	17.2+17.2
MPPT number/Max input strings number	2/2
Rated output power (Watts)	3000
Max. output power (Watts)	3300
Rated apparent output power (VA)	3000
Max. apparent output power (VA)	3300
Rated grid voltage (Volts)	1/N/PE, 230
Grid voltage range (Volts)	184...264
Rated output current (Amps)	15.7
Power Factor (at rated output power)	0.8leading~0.8lagging
THDi (at rated output power)	<5%
Rated grid frequency (Hertz)	50
Operating frequency range (Hertz)	45...55
Max. efficiency	97.8%
EU efficiency	97.1%
MPPT efficiency	>99.5%
Dimensions	310W*543H*160D (mm)
Weight	11.5kg
Topology	Non-Isolated
Operating ambient temperature range	-25°C...+60°C
Relative humidity	0-100%
Ingress protection	IP65
Noise emission (typical)	<20 dBA
Cooling concept	Natural convection
Max. operation altitude	2000m
Designed lifetime	>20 years
Grid connection standard	AS/NZS 4777.2, IEC 62116, IEC 61727, IEC 60068, IEC 61683, EN 50530
Safety/EMC standard	IEC 62109-1/-2, IEC 61000-6-2/-3
DC connection	MC4 connector
AC connection	Quick connection plug
Display	LCD, 2×20 Z
Communication	RS485, Optional: Wi-Fi, GPRS
Warranty	5 years (Extend to 20 years)

9. Specifications

Model	Solis-1P3K-4G
Max inverter backfeed current to array (Amps)	0
Peak Inrush current (Amps)	2.2
Peak Inrush Duration (ms)	5
Max output fault current (Amps)	16.25
Protective Class	Class I
Overvoltage category	II(PV), III(MAINS)
Active anti-islanding method	Active frequency shifting
Decisive voltage class	DVC

9. Specifications

Model	Solis-1P3.6K-4G
Max. DC input voltage (Volts)	600
Rated DC voltage (Volts)	330
Startup voltage (Volts)	120
MPPT voltage range (Volts)	90...520
Max. input current (Amps)	11+11
Max short circuit input current (Amps)	17.2+17.2
MPPT number/Max input strings number	2/2
Rated output power (Watts)	3600
Max. output power (Watts)	4000
Rated apparent output power (VA)	3600
Max. apparent output power (VA)	4000
Rated grid voltage (Volts)	1/N/PE, 230
Grid voltage range (Volts)	184...264
Rated output current (Amps)	16.0
Power Factor (at rated output power)	0.8leading~0.8lagging
THDi (at rated output power)	<5%
Rated grid frequency (Hertz)	50
Operating frequency range (Hertz)	45...55
Max. efficiency	97.8%
EU efficiency	97.1%
MPPT efficiency	>99.5%
Dimensions	310W*543H*160D (mm)
Weight	11.5kg
Topology	Non-Isolated
Operating ambient temperature range	-25°C...+60°C
Relative humidity	0-100%
Ingress protection	IP65
Noise emission (typical)	<20 dBA
Cooling concept	Natural convection
Max. operation altitude	2000m
Designed lifetime	>20 years
Grid connection standard	AS/NZS 4777.2, IEC 62116, IEC 61727, IEC 60068, IEC 61683, EN 50530
Safety/EMC standard	IEC 62109-1/-2, IEC 61000-6-2/-3
DC connection	MC4 connector
AC connection	Quick connection plug
Display	LCD, 2×20 Z
Communication	RS485, Optional: Wi-Fi, GPRS
Warranty	5 years (Extend to 20 years)

9. Specifications

Model	Solis-1P3.6K-4G
Max inverter backfeed current to array (Amps)	0
Peak Inrush current (Amps)	2.2
Peak Inrush Duration (ms)	5
Max output fault current (Amps)	19.625
Protective Class	Class I
Overvoltage category	II(PV), III(MAINS)
Active anti-islanding method	Active frequency shifting
Decisive voltage class	DVC

9. Specifications

Model	Solis-1P4K-4G
Max. DC input voltage (Volts)	600
Rated DC voltage (Volts)	330
Startup voltage (Volts)	120
MPPT voltage range (Volts)	90...520
Max. input current (Amps)	11+11
Max short circuit input current (Amps)	17.2+17.2
MPPT number/Max input strings number	2/2
Rated output power (Watts)	4000
Max. output power (Watts)	4400
Rated apparent output power (VA)	4000
Max. apparent output power (VA)	4400
Rated grid voltage (Volts)	1/N/PE, 230
Grid voltage range (Volts)	184...264
Rated output current (Amps)	21.0
Power Factor (at rated output power)	0.8leading~0.8lagging
THDi (at rated output power)	<5%
Rated grid frequency (Hertz)	50
Operating frequency range (Hertz)	45...55
Max. efficiency	98.1%
EU efficiency	97.3%
MPPT efficiency	>99.5%
Dimensions	310W*543H*160D (mm)
Weight	11.5kg
Topology	Non-Isolated
Operating ambient temperature range	-25°C...+60°C
Relative humidity	0-100%
Ingress protection	IP65
Noise emission (typical)	<20 dBA
Cooling concept	Natural convection
Max. operation altitude	2000m
Designed lifetime	>20 years
Grid connection standard	AS/NZS 4777.2, IEC 62116, IEC 61727, IEC 60068, IEC 61683, EN 50530
Safety/EMC standard	IEC 62109-1/-2, IEC 61000-6-2/-3
DC connection	MC4 connector
AC connection	Quick connection plug
Display	LCD, 2×20 Z
Communication	RS485, Optional: Wi-Fi, GPRS
Warranty	5 years (Extend to 20 years)

9. Specifications

Model	Solis-1P4K-4G
Max inverter backfeed current to array (Amps)	0
Peak Inrush current (Amps)	2.2
Peak Inrush Duration (ms)	5
Max output fault current (Amps)	21.75
Protective Class	Class I
Overvoltage category	II(PV), III(MAINS)
Active anti-islanding method	Active frequency shifting
Decisive voltage class	DVC

9. Specifications

Model	Solis-1P4.6K-4G
Max. DC input voltage (Volts)	600
Rated DC voltage (Volts)	330
Startup voltage (Volts)	120
MPPT voltage range (Volts)	90...520
Max. input current (Amps)	11+11
Max short circuit input current (Amps)	17.2+17.2
MPPT number/Max input strings number	2/2
Rated output power (Watts)	4600
Max. output power (Watts)	5000
Rated apparent output power (VA)	4600
Max. apparent output power (VA)	5000
Rated grid voltage (Volts)	1/N/PE, 230
Grid voltage range (Volts)	184...264
Rated output current (Amps)	23.8
Power Factor (at rated output power)	0.8leading~0.8lagging
THDi (at rated output power)	<5%
Rated grid frequency (Hertz)	50
Operating frequency range (Hertz)	45...55
Max. efficiency	98.1%
EU efficiency	97.3%
MPPT efficiency	>99.5%
Dimensions	310W*543H*160D (mm)
Weight	11.5kg
Topology	Non-Isolated
Operating ambient temperature range	-25°C...+60°C
Relative humidity	0-100%
Ingress protection	IP65
Noise emission (typical)	<20 dBA
Cooling concept	Natural convection
Max. operation altitude	2000m
Designed lifetime	>20 years
Grid connection standard	AS/NZS 4777.2, IEC 62116, IEC 61727, IEC 60068, IEC 61683, EN 50530
Safety/EMC standard	IEC 62109-1/-2, IEC 61000-6-2/-3
DC connection	MC4 connector
AC connection	Quick connection plug
Display	LCD, 2×20 Z
Communication	RS485, Optional: Wi-Fi, GPRS
Warranty	5 years (Extend to 20 years)

9. Specifications

Model	Solis-1P4.6K-4G
Max inverter backfeed current to array (Amps)	0
Peak Inrush current (Amps)	2.2
Peak Inrush Duration (ms)	5
Max output fault current (Amps)	25.0
Protective Class	Class I
Overvoltage category	II(PV), III(MAINS)
Active anti-islanding method	Active frequency shifting
Decisive voltage class	DVC

9. Specifications

Model	Solis-1P5K-4G
Max. DC input voltage (Volts)	600
Rated DC voltage (Volts)	330
Startup voltage (Volts)	120
MPPT voltage range (Volts)	90...520
Max. input current (Amps)	11+11
Max short circuit input current (Amps)	17.2+17.2
MPPT number/Max input strings number	2/2
Rated output power (Watts)	5000
Max. output power (Watts)	5000
Rated apparent output power (VA)	5000
Max. apparent output power (VA)	5000
Rated grid voltage (Volts)	1/N/PE, 230
Grid voltage range (Volts)	184...264
Rated output current (Amps)	25.0
Power Factor (at rated output power)	0.8leading~0.8lagging
THDi (at rated output power)	<5%
Rated grid frequency (Hertz)	50
Operating frequency range (Hertz)	45...55
Max. efficiency	98.1%
EU efficiency	97.3%
MPPT efficiency	>99.5%
Dimensions	310W*543H*160D (mm)
Weight	11.5kg
Topology	Non-Isolated
Operating ambient temperature range	-25°C...+60°C
Relative humidity	0-100%
Ingress protection	IP65
Noise emission (typical)	<20 dBA
Cooling concept	Natural convection
Max. operation altitude	2000m
Designed lifetime	>20 years
Grid connection standard	AS/NZS 4777.2, IEC 62116, IEC 61727, IEC 60068, IEC 61683, EN 50530
Safety/EMC standard	IEC 62109-1/-2, IEC 61000-6-2/-3
DC connection	MC4 connector
AC connection	Quick connection plug
Display	LCD, 2×20 Z
Communication	RS485, Optional: Wi-Fi, GPRS
Warranty	5 years (Extend to 20 years)

9. Specifications

Model	Solis-1P5K-4G
Max inverter backfeed current to array (Amps)	0
Peak Inrush current (Amps)	2.2
Peak Inrush Duration (ms)	5
Max output fault current (Amps)	27.125
Protective Class	Class I
Overvoltage category	II(PV), III(MAINS)
Active anti-islanding method	Active frequency shifting
Decisive voltage class	DVC

9. Specifications

Model	Solis-1P6K-4G
Max. DC input voltage (Volts)	600
Rated DC voltage (Volts)	330
Startup voltage (Volts)	120
MPPT voltage range (Volts)	90...520
Max. input current (Amps)	11+11
Max short circuit input current (Amps)	17.2+17.2
MPPT number/Max input strings number	2/2
Rated output power (Watts)	6000
Max. output power (Watts)	6000
Rated apparent output power (VA)	6000
Max. apparent output power (VA)	6000
Rated grid voltage (Volts)	1/N/PE, 230
Grid voltage range (Volts)	184...264
Rated output current (Amps)	27.3
Power Factor (at rated output power)	0.8leading~0.8lagging
THDi (at rated output power)	<5%
Rated grid frequency (Hertz)	50
Operating frequency range (Hertz)	45...55
Max. efficiency	98.1%
EU efficiency	97.3%
MPPT efficiency	>99.5%
Dimensions	310W*543H*160D (mm)
Weight	11.5kg
Topology	Non-Isolated
Operating ambient temperature range	-25°C...+60°C
Relative humidity	0-100%
Ingress protection	IP65
Noise emission (typical)	<20 dBA
Cooling concept	Natural convection
Max. operation altitude	2000m
Designed lifetime	>20 years
Grid connection standard	AS/NZS 4777.2, IEC 62116, IEC 61727, IEC 60068, IEC 61683, EN 50530
Safety/EMC standard	IEC 62109-1/-2, IEC 61000-6-2/-3
DC connection	MC4 connector
AC connection	Quick connection plug
Display	LCD, 2×20 Z
Communication	RS485, Optional: Wi-Fi, GPRS
Warranty	5 years (Extend to 20 years)

9. Specifications

Model	Solis-1P6K-4G
Max inverter backfeed current to array (Amps)	0
Peak Inrush current (Amps)	2.2
Peak Inrush Duration (ms)	5
Max output fault current (Amps)	34.125
Protective Class	Class I
Overvoltage category	II(PV), III(MAINS)
Active anti-islanding method	Active frequency shifting
Decisive voltage class	DVC

9. Specifications

Model	Solis-1P5K-4G-MX
Max. DC input voltage (Volts)	600
Rated DC voltage (Volts)	330
Startup voltage (Volts)	120
MPPT voltage range (Volts)	90...520
Max. input current (Amps)	11+11
Max short circuit input current (Amps)	17.2+17.2
MPPT number/Max input strings number	2/2
Rated output power (Watts)	4999
Max. output power (Watts)	4999
Rated apparent output power (VA)	4999
Max. apparent output power (VA)	4999
Rated grid voltage (Volts)	1/N/PE, 230
Grid voltage range (Volts)	184...264
Rated output current (Amps)	21.7
Power Factor (at rated output power)	0.8leading~0.8lagging
THDi (at rated output power)	<5%
Rated grid frequency (Hertz)	50
Operating frequency range (Hertz)	45...55
Max. efficiency	98.1%
EU efficiency	97.3%
MPPT efficiency	>99.5%
Dimensions	310W*543H*160D (mm)
Weight	11.5kg
Topology	Non-Isolated
Operating ambient temperature range	-25°C...+60°C
Relative humidity	0-100%
Ingress protection	IP65
Noise emission (typical)	<20 dBA
Cooling concept	Natural convection
Max. operation altitude	2000m
Designed lifetime	>20 years
Grid connection standard	AS/NZS 4777.2, IEC 62116, IEC 61727, IEC 60068, IEC 61683, EN 50530
Safety/EMC standard	IEC 62109-1/-2, IEC 61000-6-2/-3
DC connection	MC4 connector
AC connection	Quick connection plug
Display	LCD, 2×20 Z
Communication	RS485, Optional: Wi-Fi, GPRS
Warranty	5 years (Extend to 20 years)

9. Specifications

Model	Solis-1P5K-4G-MX
Max inverter backfeed current to array (Amps)	0
Peak Inrush current (Amps)	2.2
Peak Inrush Duration (ms)	5
Max output fault current (Amps)	27.125
Protective Class	Class I
Overvoltage category	II(PV), III(MAINS)
Active anti-islanding method	Active frequency shifting
Decisive voltage class	DVC

10. Appendix

10.1 Built-In DC Isolator Specification(Optional)

Model	GHX5-32P
Rated insulation voltage	1500V
Rated impulse withstand voltage	8000V
Suitability for isolation	Suitable for isolation
Rated operational current	30A
Utilization category	DC-PV2
Rated short-time withstand current(I _{ow})	700A
Rated short-circuit making capacity(I _{cm})	1400A
Rated breaking capacity	4*I _e 120A